

# Test Verification of Conformity

On the basis of the referenced test report(s), the sample(s) of the below product has been found to comply with the relevant harmonized standard(s) to the directive(s) listed on this verification at the time the tests were carried out. The manufacturer may indicate compliance to only the said directives by signing a DoC himself and may affix the CE marking to products identical to the tested sample(s) if the product complies with all CE marking directives that has the product in their scope. In addition, the manufacturer shall file and keep the documentation according to the rules of the applicable directive(s) and shall consider changes of the standards as they may occur. Additional requirements, additional directives and local laws may be applicable.

<b>Applicant Name &amp; Address</b>	:	<b>Eaglerise Electric &amp; Electronic (Foshan) Co., Ltd. Guicheng Sci-Tech Industrial Park, Jianping Road, Nanhai District, Foshan City, Guangdong Province, P.R. China</b>
<b>Product(s) Tested</b>	:	<b>Electronic convertor for LED (Electronic LED driver)</b>
<b>Ratings and principal characteristics</b>	:	<b>Input: 220-240 V~;50/60 Hz; Output: DC700 mA; Max. 65 VDC; 42W for ELP042C0700LSD1; DC700 mA; Max. 48 VDC; 36W for ELP036C0700LSD1; For Constant Current Type; Class II; SELV; Independent; IP20; ta: 50 °C; tc: 80 °C; Thermal protection: 110 °C; Inherently short-circuit proof; Suitable for directly mounting on normal flammability surface.</b>
<b>Model(s)</b>	:	<b>ELP042C0700LSD1; ELP036C0700LSD1</b>
<b>Brand name</b>	:	 <b>EAGLERISE</b>
<b>Relevant Standard(s) / Specification(s) / Directive(s)</b>	:	<b>EN 55015: 2006+A1: 2007+A2:2009/ Limits and methods of measurement of radio disturbance characteristics of electrical lighting and similar equipment</b>  <b>EN 61000-3-2: 2006+ A1:2009+ A2:2009/ Electromagnetic compatibility (EMC) – Part 3-2: Limits – Limits for harmonic current emissions (equipment input current ≤ 16 A per phase)</b>  <b>EN 61000-3-3: 2008/ Electromagnetic compatibility (EMC) – Part 3-3: Limits – Limitation of voltage changes, voltage fluctuations and flicker in public low-voltage supply systems, for equipment with rated current ≤ 16 A per phase and not subject to conditional connection</b>  <b>EN 61547:2009/ Equipment for general lighting purposes — EMC immunity requirements</b>  <b>EMC Directive 2004/108/EC</b>
<b>Verification Issuing Office Name &amp; Address</b>	:	<b>Same as Legal Entity</b>
<b>Verification/Report Number(s)</b>	:	<b>GZ10120369-1/ GZ10120369-1</b>

**Note 1 : This verification is part of the full test report(s) and should be read in conjunction with it.**

This Verification is for the exclusive use of Intertek's Client and is provided pursuant to the agreement between Intertek and its Client. Intertek's responsibility and liability are limited to the terms and conditions of the agreement. Intertek assumes no liability to any party, other than to the Client in accordance with the agreement, for any loss, expense or damage occasioned by the use of this Verification. Only the Client is authorized to copy or distribute this Verification. Any use of the Intertek name or one of its marks for the sale or advertisement of the tested material, product or service must first be approved in writing by Intertek. The observations and test results referenced from this Verification are relevant only to the sample tested. This Verification by itself does not imply that the material, product, or service is or has ever been under an Intertek certification program.

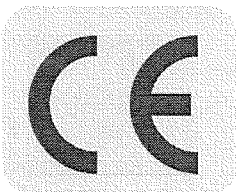

Signature

Name: Carrie Chen  
 Position: Sr. Project Engineer  
 Date: 21 January, 2011



**TEST REPORT**

Applicant Name & Address : Eaglerise Electric & Electronic (Foshan) Co., Ltd.  
 Guicheng Sci-Tech Industrial Park, Jianping Road, Nanhai District, Foshan City, Guangdong Province, P.R. China

Manufacturing Site : Eaglerise Electric & Electronic (Foshan) Co., Ltd.  
 Guicheng Sci-Tech Industrial Park, Jianping Road, Nanhai District, Foshan City, Guangdong Province, P.R. China

Sample Description

Product : Electronic convertor for LED (Electronic LED driver)

Model No. : ELP042C0700LSD1; ELP036C0700LSD1

Electrical Rating : Input: 220-240 V~;50/60 Hz; Output: DC700 mA; Max. 65 VDC; 42W for ELP042C0700LSD1; DC700 mA; Max. 48 VDC; 36W for ELP036C0700LSD1  
 For Constant Current Type; Class II; SELV; Independent; IP20; ta: 50 °C; tc: 80 °C; Thermal protection: 110 °C; Inherently short-circuit proof; Suitable for directly mounting on normal flammability surface.

Date Received : 08 December 2010

Date Test Conducted : 27 December 2010-06 January 2011

Test standards : EN 55015: 2006+A1: 2007+A2: 2009  
 EN 61000-3-2: 2006+ A1:2009+ A2:2009  
 EN 61000-3-3: 2008  
 EN 61547:2009

Test Result : Pass

Conclusion : The submitted samples complied with the above EMC standards.

Remark : None.

\*\*\*\*\*End of Page\*\*\*\*\*

*Prepared and Checked By:*

*Approved By:*

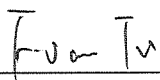
  
 \_\_\_\_\_  
**Fvan Tu**  
**Engineer**  
**Intertek Guangzhou**

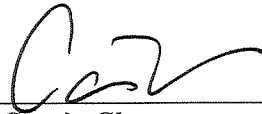
  
 \_\_\_\_\_ *Signature*  
**Carrie Chen**  
**Sr. Project Engineer**  
**Intertek Guangzhou**  
 \_\_\_\_\_ **21 January 2011** *Date*

This report is for the exclusive use of Intertek's Client and is provided pursuant to the agreement between Intertek and its Client. Intertek's responsibility and liability are limited to the terms and conditions of the agreement. Intertek assumes no liability to any party, other than to the Client in accordance with the agreement, for any loss, expense or damage occasioned by the use of this report. Only the Client is authorized to permit copying or distribution of this report and then only in its entirety. Any use of the Intertek name or one of its marks for the sale or advertisement of the tested material, product or service must first be approved in writing by Intertek. The observations and test results in this report are relevant only to the sample tested. This report by itself does not imply that the material, product, or service is or has ever been under an Intertek certification program. The test report only allows to be revised within three years from its original issued date unless further standard or the requirement was noticed.

**CONTENT**

<b>TEST REPORT</b> .....	<b>1</b>
<b>CONTENT</b> .....	<b>2</b>
<b>1 TEST RESULTS SUMMARY</b> .....	<b>4</b>
<b>2 EMC RESULTS CONCLUSION</b> .....	<b>5</b>
<b>3 LABORATORY MEASUREMENTS</b> .....	<b>6</b>
<b>4 EMI TEST</b> .....	<b>7</b>
4.1 EN 55015 CONTINUOUS CONDUCTED DISTURBANCE VOLTAGE TEST .....	7
4.1.1 <i>Used Test Equipment</i> .....	7
4.1.2 <i>Block Diagram of Test Setup</i> .....	7
4.1.3 <i>Test Setup and Procedure</i> .....	7
4.1.4 <i>Test Data</i> .....	8
4.1.5 <i>Emission Curve</i> .....	12
4.1.6 <i>Measurement Uncertainty</i> .....	14
4.2 EN 55015 RADIATED ELECTROMAGNETIC DISTURBANCE (9 kHz-30 MHz).....	14
4.2.1 <i>Used Test Equipment</i> .....	14
4.2.2 <i>Block Diagram of Test Setup</i> .....	14
4.2.3 <i>Test Setup and Procedure</i> .....	14
4.2.4 <i>Test Data</i> .....	15
4.2.5 <i>Test Curve</i> .....	17
4.2.6 <i>Measurement Uncertainty</i> .....	20
4.3 EN 55015 RADIATED ELECTROMAGNETIC DISTURBANCE (30 MHz -300 MHz, CDN METHOD) .....	20
4.3.1 <i>Used Test Equipment</i> .....	20
4.3.2 <i>Block Diagram of Test Setup</i> .....	20
4.3.3 <i>Test Setup and Procedure</i> .....	20
4.3.4 <i>Test Data</i> .....	21
4.3.5 <i>Test Curve</i> .....	22
4.3.6 <i>Measurement uncertainty</i> .....	23
4.4 INSERTION LOSS .....	23
<b>5 HARMONICS OF CURRENT</b> .....	<b>23</b>
5.1 USED TEST EQUIPMENT.....	23
5.2 BLOCK DIAGRAM OF TEST SETUP .....	23
5.3 TEST SETUP AND PROCEDURE .....	23
5.4 TEST DATA.....	24
5.5 MEASUREMENT UNCERTAINTY .....	27
<b>6 FLICKER</b> .....	<b>28</b>
6.1 USED TEST EQUIPMENT.....	28
6.2 BLOCK DIAGRAM OF TEST SETUP .....	28
6.3 TEST SETUP AND PROCEDURE .....	28
6.3.1 <i>Definition</i> .....	28
6.3.2 <i>Test condition</i> .....	28
6.4 TEST DATA.....	29
6.5 MEASUREMENT UNCERTAINTY .....	30
<b>7 EMS TEST</b> .....	<b>31</b>
7.1 EN 61000-4-2(PURSUANT TO EN 61547) ELECTROSTATIC DISCHARGE IMMUNITY .....	31
7.1.1 <i>Used Test Equipment</i> .....	31
7.1.2 <i>Block Diagram of Test Setup</i> .....	32
7.1.3 <i>Test Setup and Procedure</i> .....	32

7.1.4	Test Result.....	34
7.2	EN 61000-4-6(PURSUANT TO EN 61547) INJECTED CURRENT (0.15 MHz TO 80 MHz) .....	35
7.2.1	Used Test Equipment .....	35
7.2.2	Block Diagram of Test Setup.....	35
7.2.3	Test Setup and Procedure .....	35
7.2.4	Test Result.....	36
7.3	EN 61000-4-4(PURSUANT TO EN 61547) ELECTRICAL FAST TRANSIENT/BURST .....	36
7.3.1	Used Test Equipment .....	36
7.3.2	Block Diagram of Test Setup.....	36
7.3.3	Test Setup and Procedure .....	37
7.3.4	Test Result.....	37
7.4	EN 61000-4-5(PURSUANT TO EN 61547) SURGE IMMUNITY .....	38
7.4.1	Used Test Equipment .....	38
7.4.2	Block Diagram of Test Setup.....	38
7.4.3	Test Setup and Procedure .....	38
7.4.4	Test Result.....	39
7.5	EN 61000-4-11(PURSUANT TO EN 61547) VOLTAGE DIPS AND INTERRUPTIONS .....	39
7.5.1	Used Test Equipment .....	39
7.5.2	Block Diagram of Test Setup.....	39
7.5.3	Test Setup and Procedure .....	40
7.5.4	Test Result.....	40
7.6	EN 61000-4-3(PURSUANT TO EN 61547) RADIATED ELECTROMAGNETIC FIELD IMMUNITY .....	41
7.6.1	Used Test Equipment .....	41
7.6.2	Block Diagram of Test Setup.....	41
7.6.3	Test Setup and Procedure .....	42
7.6.4	Test Result.....	42
7.7	EN 61000-4-8(PURSUANT TO EN 61547) POWER FREQUENCY MAGNETIC FIELD IMMUNITY .....	43
<b>8</b>	<b>APPENDIX I - PHOTOS OF TEST SETUP (REPRESENTATIVE) .....</b>	<b>44</b>
<b>9</b>	<b>APPENDIX II- PHOTOS OF EUT.....</b>	<b>49</b>

## TEST RESULTS SUMMARY

<b>Test Item</b>	<b>Standard</b>	<b>Result</b>
<b>Continuous conducted disturbance voltage</b>	EN 55015: 2006+A1: 2007+A2: 2009	<b>Pass</b>
<b>Radiated electromagnetic disturbance (9 kHz -30 MHz)</b>	EN 55015: 2006+A1: 2007+A2: 2009	<b>Pass</b>
<b>Radiated Electromagnetic Disturbance (30 MHz -300 MHz)</b>	EN 55015: 2006+A1: 2007+A2: 2009	<b>Pass</b>
<b>Insertion loss</b>	EN 55015: 2006+A1: 2007+A2: 2009	<b>N/A</b>
<b>Harmonic of current</b>	EN 61000-3-2: 2006+ A1:2009+ A2:2009	<b>Pass</b>
<b>Flicker</b>	EN 61000-3-3: 2008	<b>Pass</b>
<b>ESD immunity</b>	EN 61547:2009 Reference: EN 61000-4-2: 2009	<b>Pass</b>
<b>Inject current immunity</b>	EN 61547:2009 Reference: EN 61000-4-6:2009	<b>Pass</b>
<b>Surge immunity</b>	EN 61547:2009 Reference: EN 61000-4-5:2006	<b>Pass</b>
<b>EFT immunity</b>	EN 61547:2009 Reference: EN 61000-4-4:2004	<b>Pass</b>
<b>Radiated EM filed immunity</b>	EN 61547:2009 Reference: EN 61000-4-3:2006+A1 :2008	<b>Pass</b>
<b>Voltage dips and interruption immunity</b>	EN 61547:2009 Reference: EN 61000-4-11:2004	<b>Pass</b>
<b>Power frequency magnetic field immunity</b>	EN 61547:2009 Reference: EN 61000-4-8:1993+A1:2001	<b>N/A</b>

Remark: 1. The symbol “N/A” in above table means Not Applicable.

2. When determining the test results, measurement uncertainty of tests has been considered.

**2****EMC Results Conclusion**  
(with Justification)

RE: EMC Testing Pursuant to EMC Directive 2004/108/EC Performed on the Electronic convertor for LED (Electronic LED driver), Models: ELP042C0700LSD1; ELP036C0700LSD1.

We tested the Electronic convertor for LED (Electronic LED driver), Model: ELP042C0700LSD1; ELP036C0700LSD1, to determine if it was in compliance with the relevant EN standards as marked on the Test Results Summary. We found that the unit met the requirement of EN 55015, EN 61000-3-2, EN 61000-3-3, EN 61547 (EN 61000-4-2), EN 61547 (EN 61000-4-4), EN 61547 (EN 61000-4-6), EN 61547 (EN 61000-4-5), EN 61547 (EN 61000-4-11), & EN 61547 (EN 61000-4-3) standards when tested as received. The worst case's test data was presented in this test report. Test item Radiated EM filed immunity were subcontracted.

The production units are required to conform to the initial sample as received when the units are placed on the market.

### 3 LABORATORY MEASUREMENTS

#### Configuration Information

<b>Equipment Under Test (EUT):</b>	Electronic convertor for LED (Electronic LED driver)
<b>Model:</b>	ELP042C0700LSD1; ELP036C0700LSD1
<b>Serial No.</b>	Not Labelled
<b>Support Equipment:</b>	LED lamps provided by client
<b>Rated Voltage:</b>	220-240 V~,50/60 Hz
<b>Condition of Environment:</b>	Temperature : 15~25°C Relative Humidity: 35~60% Atmosphere Pressure 86~106kPa

**Notes:**

1. The EMI measurements had been made in the operating mode produced the largest emission in the frequency band being investigated consistent with normal applications. An attempt had been made to maximize the emission by varying the configuration of the EUT.
2. The EMS measurements had been made in the frequency bands being investigated, with the EUT in the most susceptible operating mode consistent with normal applications. The configuration of the test sample had been varied to achieve maximum susceptibility.

## 4 EMI TEST

### 4.1 EN 55015 Continuous Conducted Disturbance Voltage Test

**Test Result: Pass**

#### 4.1.1 Used Test Equipment

Equipment No.	Equipment	Model	Manufacturer
EM080-05	EMI receiver	ESCI	R&S
EM006-05	LISN	ENV216	R&S
EM004-03	EMC shield Room	8m×4m×3m	Zhongyu

#### 4.1.2 Block Diagram of Test Setup

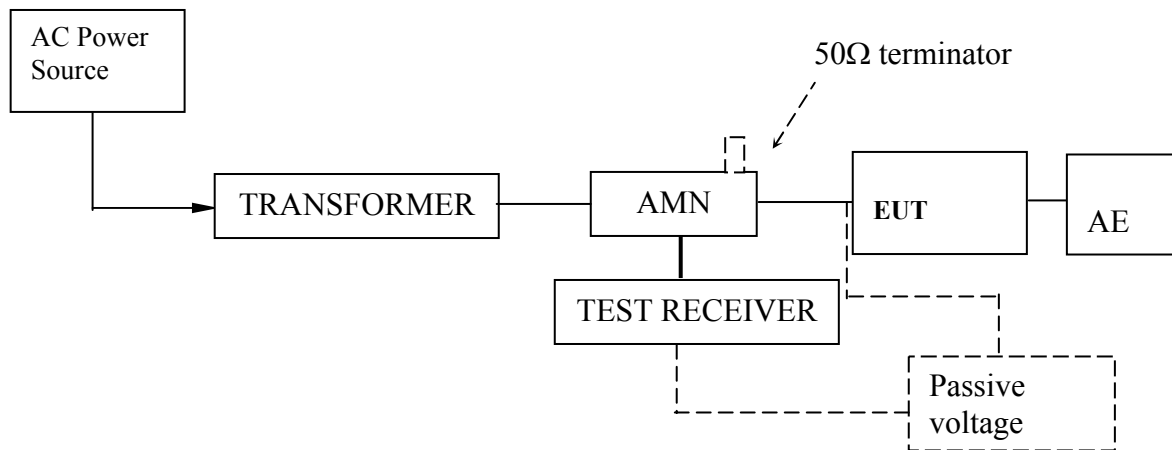

#### 4.1.3 Test Setup and Procedure

The EUT was set to achieve the maximum emission level. The mains terminal disturbance voltage was measured with the EUT in a shielded room. The EUT was connected to AC power source through an Artificial Mains Network which provide a 50Ω linear impedance. Artificial hand is used if appropriate (for handheld apparatus). The load/control terminal disturbance voltage was measured with passive voltage probe if appropriate.

The EUT was placed on a 0.4m high non-metallic table above a metallic plane, and 0.4m from wall of shielded room which is considered as Ground Reference Plane (GRP) (For floor standing EUT, was placed on a 0.1m high non-metallic supported on GRP) The EUT keeps a distance of at least 0.8m from any other of the metallic surface. The Artificial Mains Network is situated at a distance of 0.8m from the EUT.

During the test, mains lead of EUT excess 0.8m was folded back and forth parallel to the lead so as to form a horizontal bundle with a length between 0.3m and 0.4m.

The bandwidth of test receiver was set at 200Hz in the frequency range from 9kHz to 150kHz, and 9kHz in the frequency range from 150kHz to 30MHz.





#### 4.1.4 Test Data

At main terminal: Pass

Model: ELP036C0700LSD1

Tested Wire: Live

Operation Mode: EUT on

EDIT PEAK LIST (Final Measurement Results)				
TRACE	FREQUENCY	LEVEL dB $\mu$ V	DELTA	LIMIT dB
Trace1:	CE1511QP			
Trace2:	CE1511AV			
Trace3:	---			
2 Average	150 kHz	24.00 L1	-31.99	
1 Quasi Peak	158 kHz	47.77 L1	-17.79	
1 Quasi Peak	190 kHz	43.65 L1	-20.38	
1 Quasi Peak	338 kHz	46.53 L1	-12.71	
2 Average	438 kHz	30.61 L1	-16.48	
2 Average	718 kHz	23.34 L1	-22.65	
1 Quasi Peak	722 kHz	41.95 L1	-14.04	
1 Quasi Peak	1.29 MHz	39.63 L1	-16.36	
2 Average	1.29 MHz	25.81 L1	-20.18	
2 Average	2.162 MHz	30.40 L1	-15.59	
1 Quasi Peak	2.37 MHz	41.59 L1	-14.40	
1 Quasi Peak	2.39 MHz	45.20 L1	-10.80	
2 Average	2.45 MHz	30.78 L1	-15.21	
2 Average	4.314 MHz	25.29 L1	-20.70	
1 Quasi Peak	4.886 MHz	36.32 L1	-19.67	
1 Quasi Peak	10.83 MHz	36.43 L1	-23.56	
1 Quasi Peak	11.118 MHz	35.82 L1	-24.17	
1 Quasi Peak	20.722 MHz	36.36 L1	-23.64	



Tested Wire: Neutral

Operation Mode: EUT on

EDIT PEAK LIST (Final Measurement Results)				
Trace1:	CE1511QP			
Trace2:	CE1511AV			
Trace3:	---			
TRACE	FREQUENCY	LEVEL dBμV		DELTA LIMIT dB
2 Average	12.76 kHz	69.49 L1		
2 Average	15.4 kHz	39.61 L1		
2 Average	25.64 kHz	43.47 L1		
2 Average	41.72 kHz	4.21 L1		
2 Average	73.08 kHz	51.44 L1		
2 Average	150 kHz	15.11 L1		-40.88
1 Quasi Peak	334 kHz	42.50 L1		-16.85
1 Quasi Peak	802 kHz	36.04 L1		-19.95
2 Average	1.314 MHz	26.53 L1		-19.46
1 Quasi Peak	1.318 MHz	40.01 L1		-15.98
1 Quasi Peak	2.19 MHz	45.32 L1		-10.67
2 Average	2.19 MHz	32.29 L1		-13.70
1 Quasi Peak	2.686 MHz	45.74 L1		-10.25
2 Average	2.686 MHz	32.78 L1		-13.21
1 Quasi Peak	4.198 MHz	40.10 L1		-15.89
2 Average	4.198 MHz	28.74 L1		-17.25
1 Quasi Peak	8.93 MHz	36.09 L1		-23.90
1 Quasi Peak	10.974 MHz	35.49 L1		-24.50



Model: ELP042C0700LSD1

Tested Wire: Live

Operation Mode: EUT on

EDIT PEAK LIST (Final Measurement Results)				
Trace1:	CE1511QP			
Trace2:	CE1511AV			
Trace3:	---			
TRACE	FREQUENCY	LEVEL dB $\mu$ V		DELTA LIMIT dB
1 Quasi Peak	67.56 kHz	54.79	L1	-32.46
2 Average	136.92 kHz	36.12	L1	
1 Quasi Peak	154 kHz	51.94	L1	-13.83
1 Quasi Peak	290 kHz	46.51	L1	-14.00
2 Average	342 kHz	31.30	L1	-17.85
1 Quasi Peak	418 kHz	39.19	L1	-18.29
2 Average	546 kHz	29.41	L1	-16.58
1 Quasi Peak	614 kHz	42.07	L1	-13.92
2 Average	1.294 MHz	27.94	L1	-18.05
1 Quasi Peak	1.306 MHz	41.27	L1	-14.72
2 Average	2.25 MHz	32.09	L1	-13.90
1 Quasi Peak	2.254 MHz	45.09	L1	-10.90
2 Average	2.45 MHz	31.21	L1	-14.78
1 Quasi Peak	2.462 MHz	45.64	L1	-10.35
2 Average	4.626 MHz	24.20	L1	-21.79
1 Quasi Peak	4.822 MHz	34.06	L1	-21.93
1 Quasi Peak	7.482 MHz	33.71	L1	-26.28



**Tested Wire: Neutral**

**Operation Mode: EUT on**

EDIT PEAK LIST (Final Measurement Results)				
TRACE	FREQUENCY	LEVEL dB $\mu$ V	DELTA	LIMIT dB
Trace1:	CE1511QP			
Trace2:	CE1511AV			
Trace3:	---			
2 Average	25.56 kHz	43.42 L1		
1 Quasi Peak	68.36 kHz	58.54 L1	-28.60	
2 Average	68.36 kHz	52.97 L1		
1 Quasi Peak	69.24 kHz	58.05 L1	-28.98	
2 Average	69.32 kHz	52.44 L1		
2 Average	150 kHz	19.77 L1	-36.22	
1 Quasi Peak	154 kHz	47.15 L1	-18.62	
1 Quasi Peak	290 kHz	46.09 L1	-14.42	
1 Quasi Peak	386 kHz	37.09 L1	-21.05	
1 Quasi Peak	522 kHz	33.58 L1	-22.41	
1 Quasi Peak	1.378 MHz	40.29 L1	-15.70	
2 Average	1.386 MHz	26.33 L1	-19.67	
2 Average	2.282 MHz	33.08 L1	-12.91	
1 Quasi Peak	2.306 MHz	43.16 L1	-12.83	
2 Average	2.482 MHz	34.01 L1	-11.98	
1 Quasi Peak	2.486 MHz	46.80 L1	-9.19	
2 Average	4.01 MHz	27.32 L1	-18.67	
1 Quasi Peak	4.262 MHz	40.69 L1	-15.30	
1 Quasi Peak	7.382 MHz	37.35 L1	-22.64	

**At load/control terminal: Not Applicable**

### 4.1.5 Emission Curve

At mains terminal:

Model: ELP036C0700LSD1

Tested Wire: Live

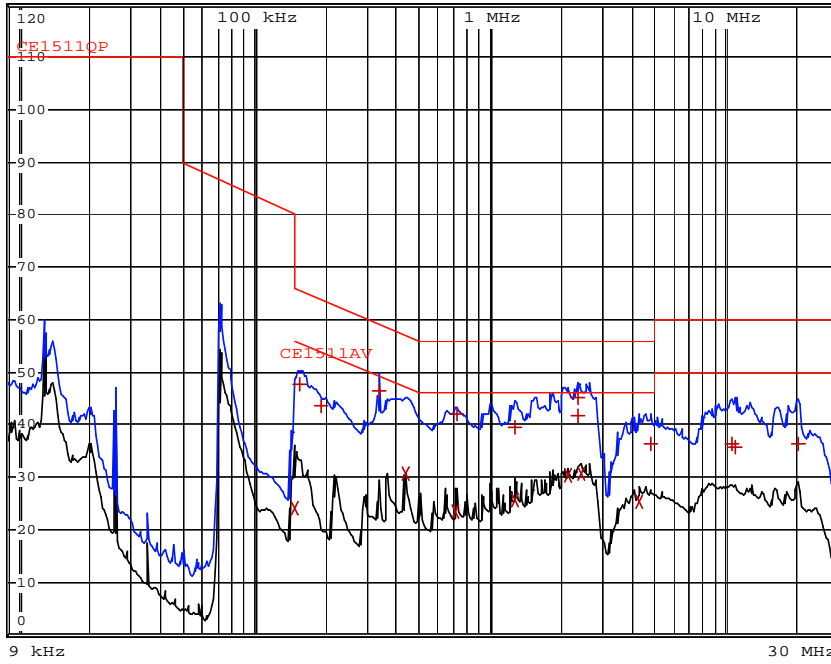

Tested Wire: Neutral

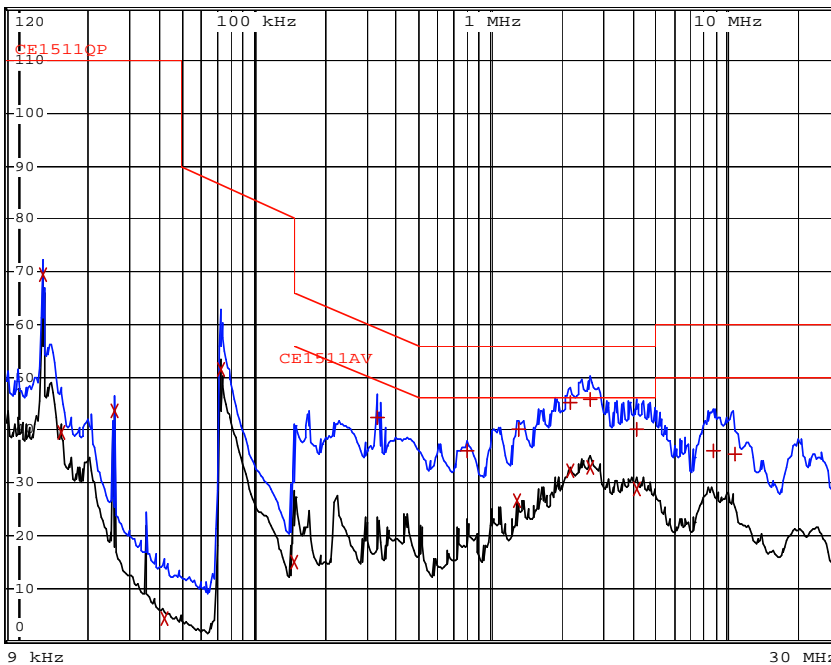



Model: ELP042C0700LSD1

Tested Wire: Live

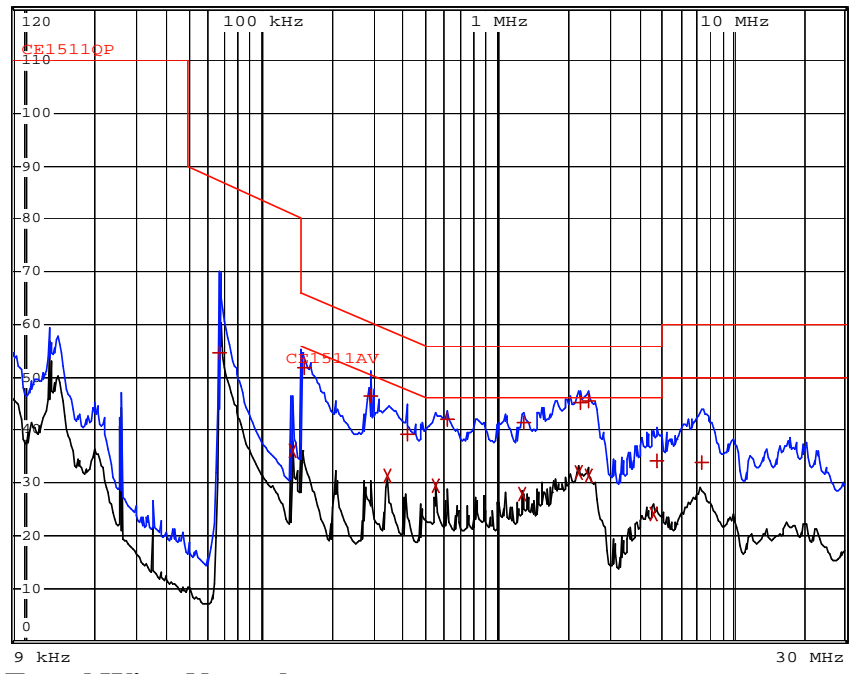

Tested Wire: Neutral

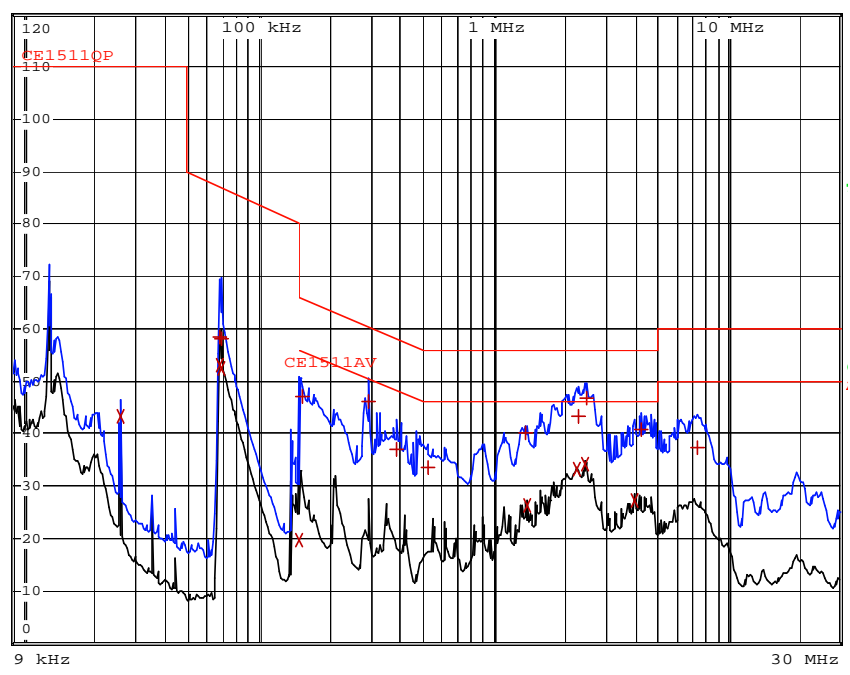

**At load/control terminal:**

**Not Applicable.**

**4.1.6 Measurement Uncertainty**

The measurement uncertainty describes the overall uncertainty of the given measured value during the operation of the EUT.

Measurement uncertainty is calculated in accordance with CISPR 16-4-2:2003.

Measurement uncertainty of mains terminal disturbance voltage in CISPR band A: 1.5dB.

Measurement uncertainty of mains terminal disturbance voltage in CISPR band B: 2.5dB.

The measurement uncertainty is given with a confidence of 95%, k=2.

**4.2 EN 55015 Radiated Electromagnetic Disturbance (9 kHz-30 MHz)**

**Test Result: Pass**

**4.2.1 Used Test Equipment**

Equipment No.	Equipment	Model	Manufacturer
EM080-05	EMI receiver	ESCI	R&S
EM061-04	Triple Loop Antenna	HXYZ9170	SCHWARZBECK
EM004-03	EMC shield Room	8m×4m×3m	Zhongyu

**4.2.2 Block Diagram of Test Setup**

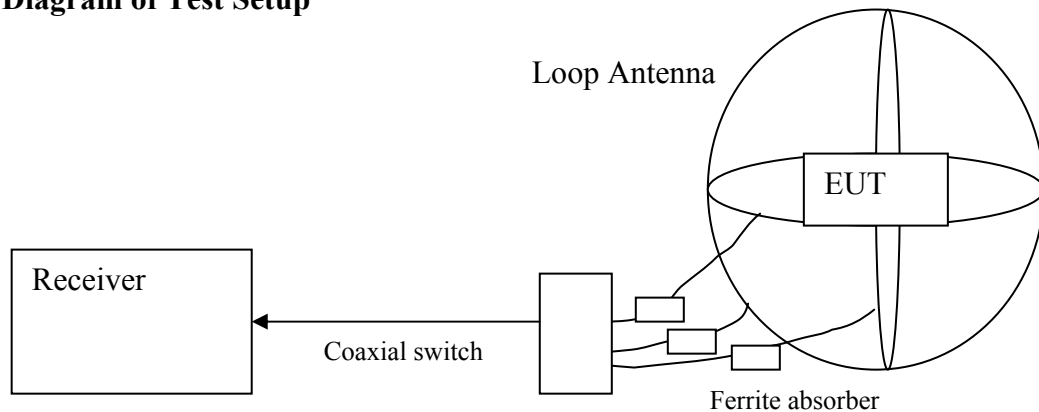

**4.2.3 Test Setup and Procedure**

The EUT is placed in the centre of the loop antenna system(LAS). The current induced by the magnetic field from the EUT into each of the three large loop antennas of the LAS is measured by connecting the current probe of the large loop antenna to a measuring receiver. During the measurements the EUT remains in a fixed position.

The currents in the three large loop antenna, origination from the three mutually orthogonal magnetic field components, are measured in sequence. Each current level measured shall comply with the emission limit, expressed in dBµA, as specified in table of EN 55015.

The distance between the outer perimeter of the LAS and nearby objects, such as floor and walls, shall be at least 0.5m.

To avoid unwanted capacitive coupling between the EUT and the LAS, the maximum dimensions of the EUT shall allow a distance of at least 0.2m between the EUT and the standardized 2m large loop antenna of the LAS.

The position of the mains lead shall be optimized for maximum current induction. In general, this position will not be critical when the EUT complies with the conducted emission limit.

**4.2.4 Test Data**

**Model: ELP036C0700LSD1**

<b>Frequency [MHz]</b>	<b>X axis [dB(μA)]</b>	<b>Y axis [dB(μA)]</b>	<b>Z axis [dB(μA)]</b>	<b>Limit [dB(μA)]</b>
0.009	<78	<78	<78	88.0
0.050	<78	<78	<78	88.0
0.100	<64	<64	<64	74.0
0.160	<47	<47	<47	57.2
0.240	<40	<40	<40	52.4
0.550	<30	<30	<30	42.5
1.000	<25	<25	<25	35.4
1.400	<20	<20	<20	31.4
2.000	<17	<17	<17	27.1
3.500	<12	<12	<12	22.0
6.000	<12	<12	<12	22.0
10.000	<12	<12	<12	22.0
22.000	<12	<12	<12	22.0
30.000	<12	<12	<12	22.0



**Model: ELP042C0700LSD1**

<b>Frequency [MHz]</b>	<b>X axis [dB(μA)]</b>	<b>Y axis [dB(μA)]</b>	<b>Z axis [dB(μA)]</b>	<b>Limit [dB(μA)]</b>
0.009	<78	<78	<78	88.0
0.050	<78	<78	<78	88.0
0.100	<64	<64	<64	74.0
0.160	<47	<47	<47	57.2
0.240	<40	<40	<40	52.4
0.550	<30	<30	<30	42.5
1.000	<25	<25	<25	35.4
1.400	<20	<20	<20	31.4
2.000	<17	<17	<17	27.1
3.500	<12	<12	<12	22.0
6.000	<12	<12	<12	22.0
10.000	<12	<12	<12	22.0
22.000	<12	<12	<12	22.0
30.000	<12	<12	<12	22.0

### 4.2.5 Test Curve

Model: ELP036C0700LSD1

X axis

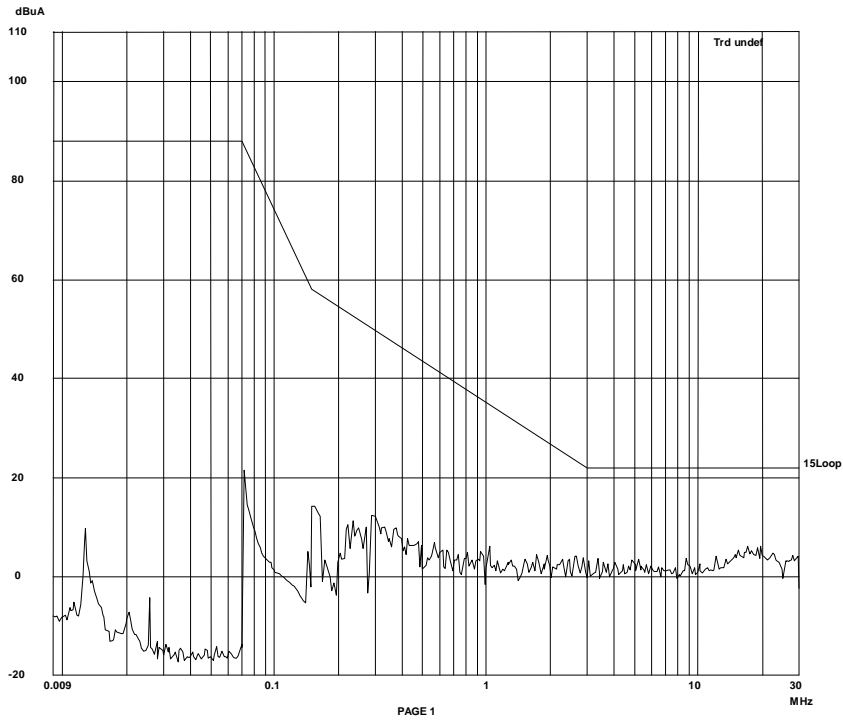

Y axis

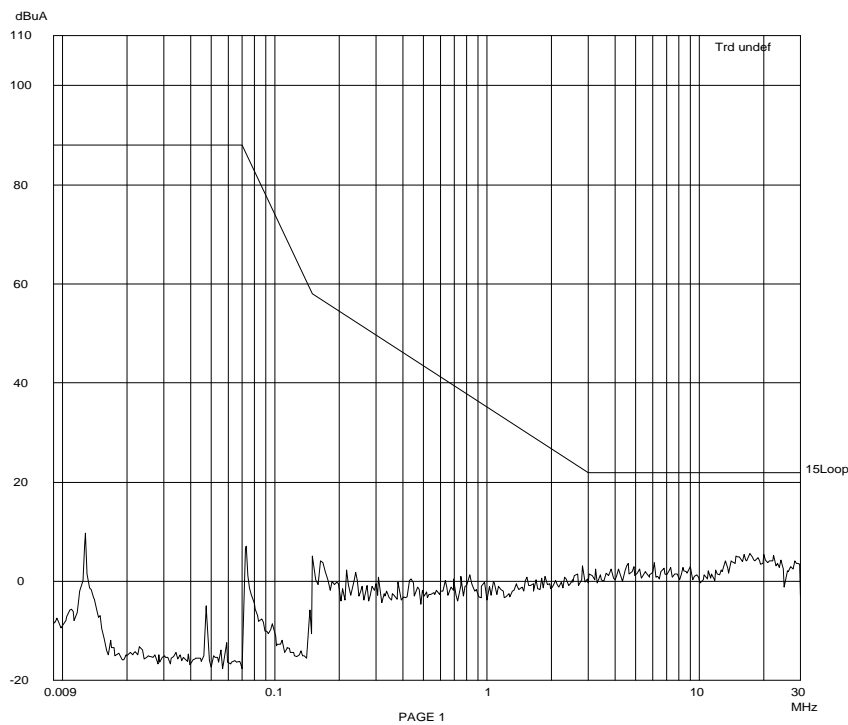

Z axis

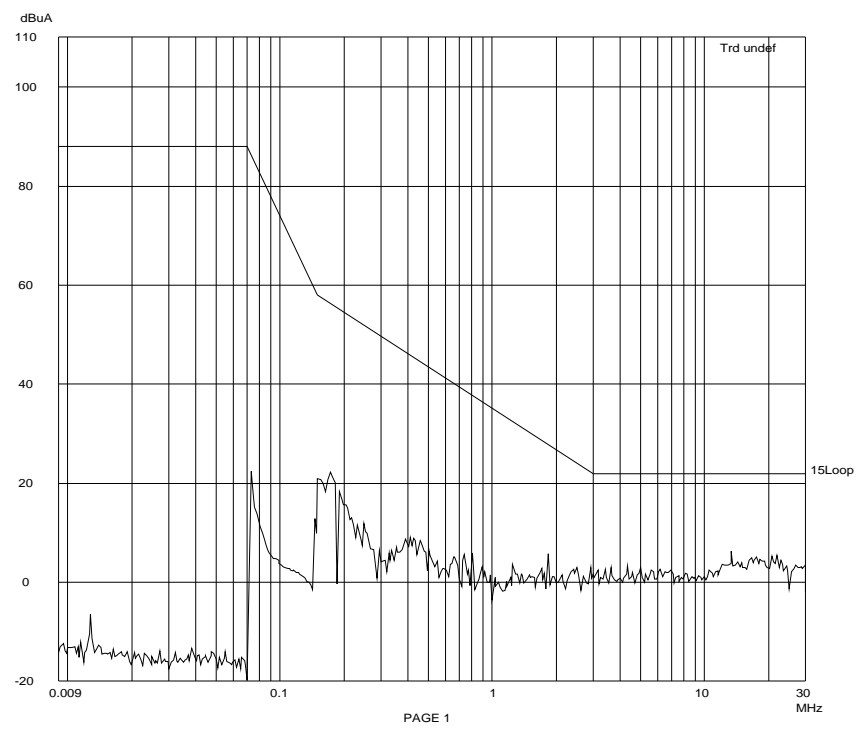

Model: ELP042C0700LSD1

X axis

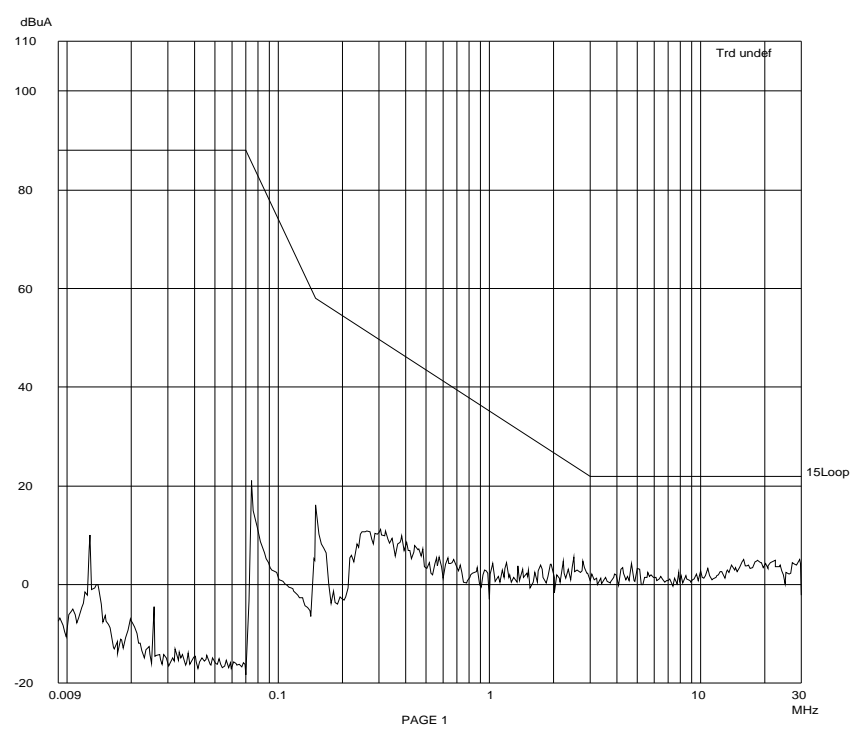

### Y axis

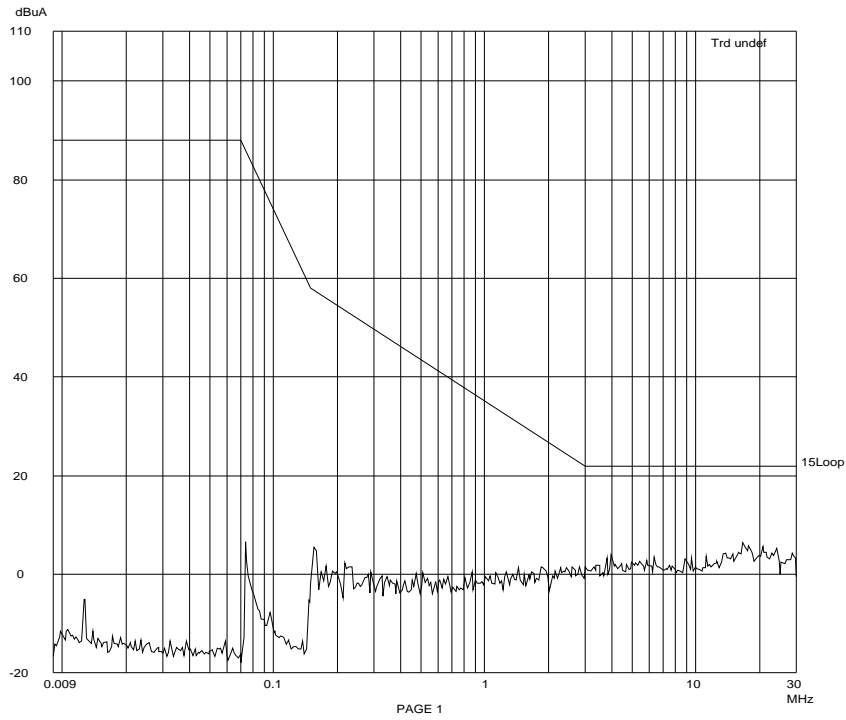

### Z axis

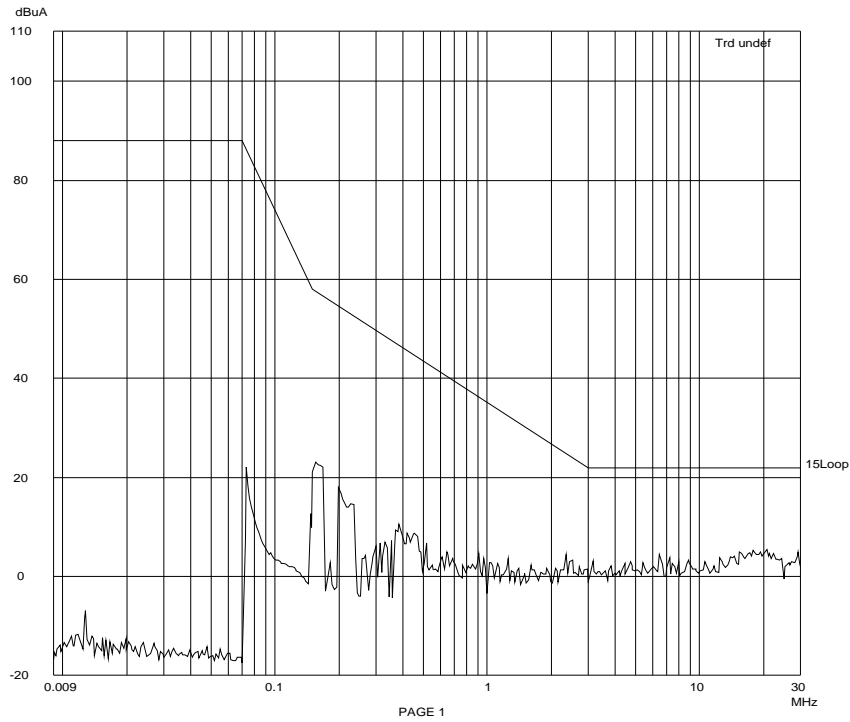

#### 4.2.6 Measurement Uncertainty

The measurement uncertainty for induction current is under consideration according to CISPR 16-4-2:2003.

### 4.3 EN 55015 Radiated Electromagnetic Disturbance (30 MHz -300 MHz, CDN method) Test Result: Pass

#### 4.3.1 Used Test Equipment

Equip. No.	Equipment	Model	Manufacturer
EM004-03	EMC shield Room	8m×4m×3m	Zhongyu
EM080-05	EMI receiver	ESCI	R&S
EM003-02	Coupling & Decoupling Network	CDN M2 16	TESEQ
EM003-01-05	Attenuator	6dB	drhubert

#### 4.3.2 Block Diagram of Test Setup

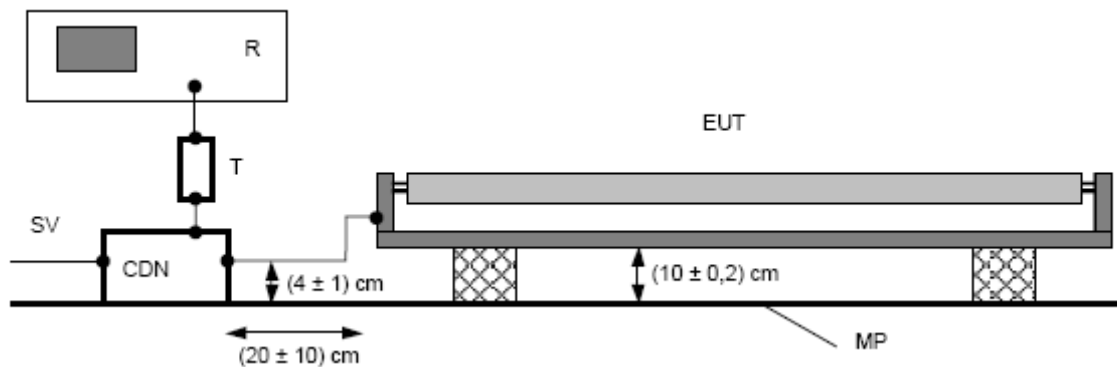

#### 4.3.3 Test Setup and Procedure

The EUT shall be placed on a non-conducting table with a height of  $(10 \pm 0.2)$  cm.  
 The EUT is connected to CDN with a length of  $(20 \pm 10)$  cm and the distance of the cable to the metal plate should be  $(4 \pm 1)$  cm.  
 The RF output of the CDN is connected to EMI receiver via a 6 dB, 50Ω attenuator.  
 The distance from any conductive parts shall be more than 40 cm.

Prior to a measurement, the lamps shall be operated until stabilization has been reached.  
 5min for incandescent lamps, 15min for fluorescent lamp, 30min for other discharge lamp.

The EUT should be powered on before the coaxial cable is connected to receiver every time.  
 And the coaxial cable should be removed from receiver before stopping EUT.

### 4.3.4 Test Data

#### Model: ELP036C0700LSD1

EDIT PEAK LIST (Final Measurement Results)				
Trace1:	15CDN			
Trace2:	---			
Trace3:	---			
TRACE	FREQUENCY	LEVEL	dB $\mu$ V	DELTA LIMIT dB
1 Quasi Peak	82.36 MHz	49.98	L1	-5.62
1 Quasi Peak	82.12 MHz	49.41	L1	-6.22
1 Quasi Peak	197.08 MHz	45.74	L1	-8.25
1 Quasi Peak	70.48 MHz	47.98	L1	-8.92
1 Quasi Peak	161 MHz	44.32	L1	-9.67
1 Quasi Peak	108.2 MHz	44.04	L1	-9.95
1 Quasi Peak	169.96 MHz	43.68	L1	-10.31
1 Quasi Peak	117.68 MHz	42.00	L1	-11.99
1 Quasi Peak	146.08 MHz	40.96	L1	-13.03
1 Quasi Peak	60.92 MHz	44.24	L1	-13.87
1 Quasi Peak	226.52 MHz	35.24	L1	-18.75
1 Quasi Peak	51.96 MHz	38.02	L1	-21.41
1 Quasi Peak	35.92 MHz	40.80	L1	-21.69
1 Quasi Peak	30.68 MHz	39.45	L1	-24.36
1 Quasi Peak	41.88 MHz	36.83	L1	-24.39

#### Model: ELP042C0700LSD1

EDIT PEAK LIST (Final Measurement Results)				
Trace1:	15CDN			
Trace2:	---			
Trace3:	---			
TRACE	FREQUENCY	LEVEL	dB $\mu$ V	DELTA LIMIT dB
1 Quasi Peak	84.32 MHz	47.58	L1	-7.82
1 Quasi Peak	81.84 MHz	45.49	L1	-10.16
1 Quasi Peak	206.12 MHz	43.23	L1	-10.76
1 Quasi Peak	194.04 MHz	42.10	L1	-11.90
1 Quasi Peak	150.2 MHz	39.47	L1	-14.52
1 Quasi Peak	129.52 MHz	39.13	L1	-14.86
1 Quasi Peak	123.56 MHz	38.48	L1	-15.51
1 Quasi Peak	67.28 MHz	39.10	L1	-18.18
1 Quasi Peak	48.76 MHz	40.73	L1	-19.22
1 Quasi Peak	42.48 MHz	41.70	L1	-19.41
1 Quasi Peak	226.04 MHz	34.32	L1	-19.67
1 Quasi Peak	61.6 MHz	38.08	L1	-19.94
1 Quasi Peak	107.32 MHz	32.31	L1	-21.68
1 Quasi Peak	37.28 MHz	40.23	L1	-21.95
1 Quasi Peak	32.48 MHz	41.10	L1	-22.23

### 4.3.5 Test Curve

**Model: ELP036C0700LSD1**

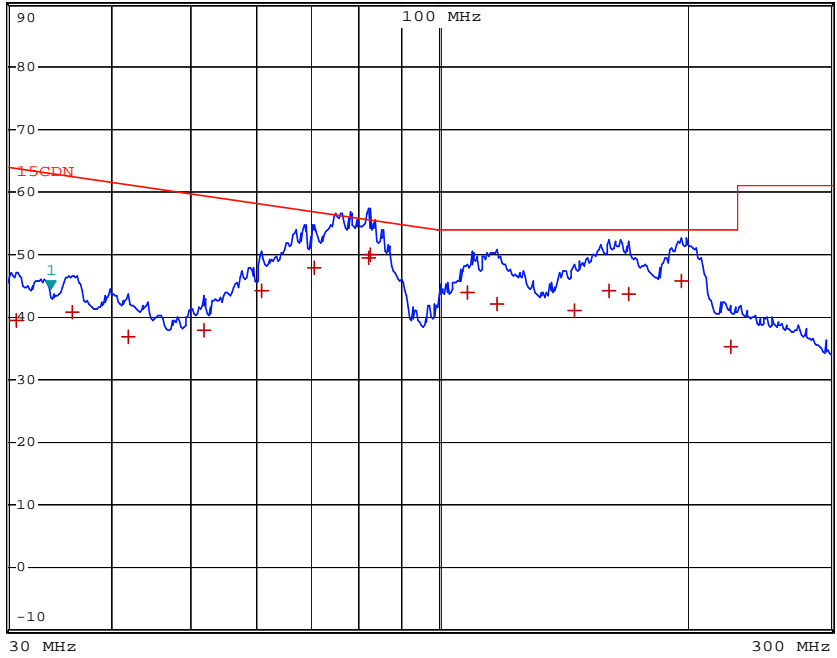

**Model: ELP042C0700LSD1**

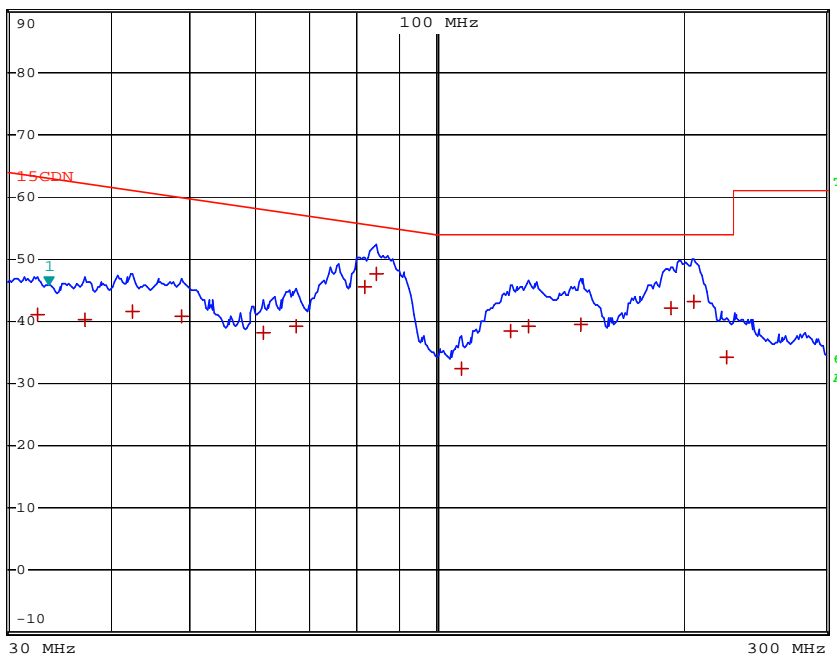

**4.3.6 Measurement uncertainty**

The measurement uncertainty for Radiated Electromagnetic Disturbance t (30 MHz -300 MHz, CDN method) is under consideration according to CISPR 16-4-2:2003.

**4.4 Insertion Loss**

**Test Result: Not Applicable.**

**Remark: Not required by standard.**

**5 Harmonics of current**

**Test Result: Pass**

**5.1 Used Test Equipment**

Equipment No.	Equipment	Model	Manufacturer
EM001-02	Harmonic & Flicker Test System	5001IX-CTS-400-413	California Instrument

**5.2 Block Diagram of Test Setup**

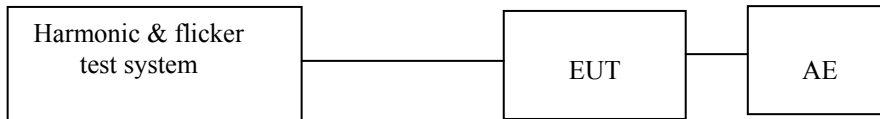

**5.3 Test Setup and Procedure**

Harmonics of the fundamental current were measured up to 40 order harmonics using a digital power meter with an analogue output and frequency analyser which was integrated in the harmonic & flicker test system. The measurements were carried out under steady conditions.

□ EUT is not discharge lighting, the harmonics currents limits are not specified for the equipment with a rated power smaller than or equal to 25W. Therefore the EUT was deemed fulfill the requirements of relative standard without testing.



**5.4 Test Data**

**Model: ELP036C0700LSD1**

**Harmonics – Class-C per Ed. 3.2 (incl. inter-harmonics)**

Current & voltage waveforms

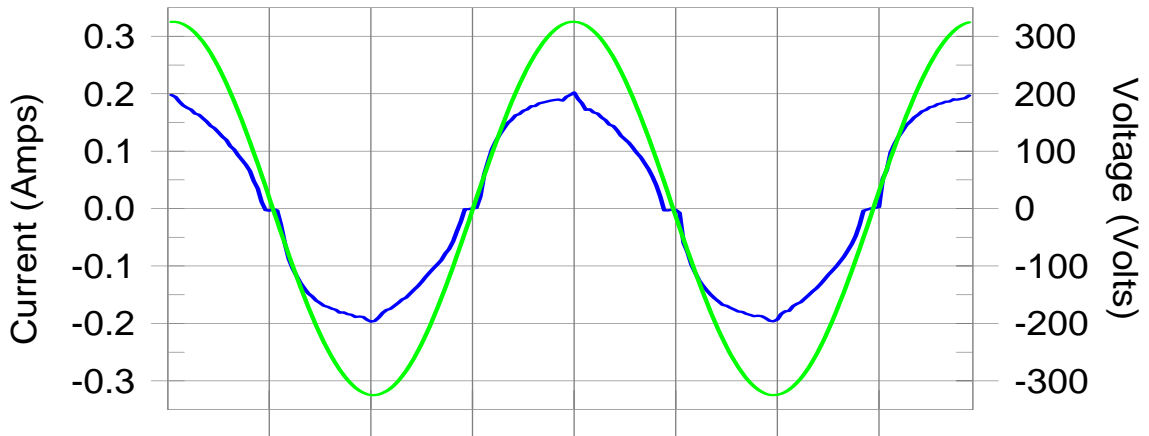

Harmonics and Class C limit line

European Limits

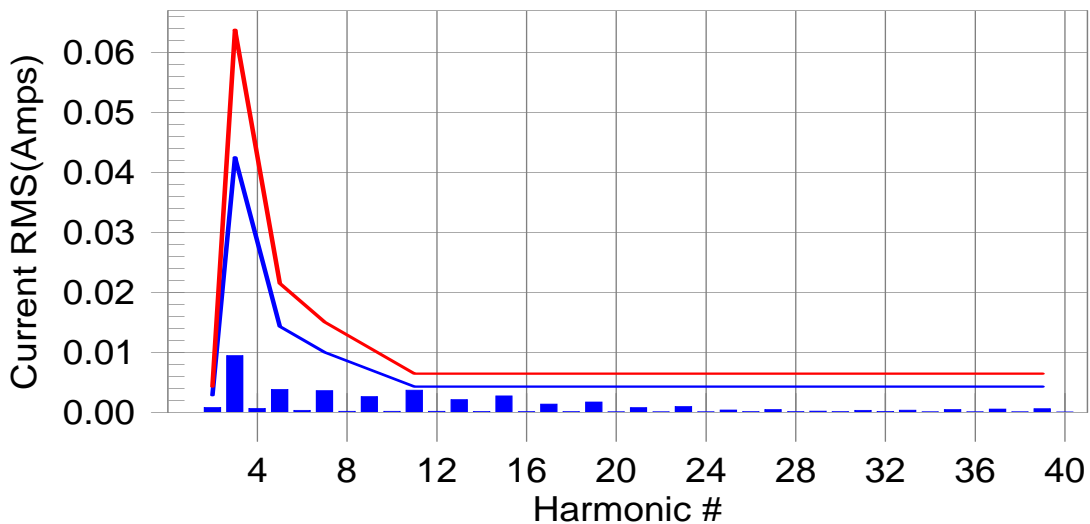

**Test result: Pass Worst harmonics H5-28.90% of 100% limit, H5-23.29% of 150% limit.**



### Current Test Result Summary (Run time)

Test Result: Pass

Source qualification: Normal

Highest parameter values during test:

V_RMS (Volts):	230.04	Frequency(Hz):	50.00
I_Peak (Amps):	0.207	I_RMS (Amps):	0.144
I_Fund (Amps):	0.143	Crest Factor:	1.453
Power (Watts):	32.7	Power Factor:	0.989

Harm#	Harms(avg)	100%Limit	%of Limit	Harms(max)	150%Limit	%of Limit	Status
2	0.001	0.003	0.0	0.001	0.004	0.00	Pass
3	0.010	0.043	22.3	0.011	0.000	0.00	Pass
4	0.001						
5	0.004	0.014	28.9	0.005	0.022	23.29	Pass
6	0.000						
7	0.004	0.010	0.0	0.004	0.015	0.00	Pass
8	0.000						
9	0.003	0.007	0.0	0.003	0.011	0.00	Pass
10	0.000						
11	0.004	0.004	0.0	0.004	0.006	0.00	Pass
12	0.000						
13	0.002	0.004	0.0	0.002	0.006	0.00	Pass
14	0.000						
15	0.003	0.004	0.0	0.003	0.006	0.00	Pass
16	0.000						
17	0.001	0.004	0.0	0.001	0.006	0.00	Pass
18	0.000						
19	0.002	0.004	0.0	0.002	0.006	0.00	Pass
20	0.000						
21	0.001	0.004	0.0	0.001	0.006	0.00	Pass
22	0.000						
23	0.001	0.004	0.0	0.001	0.006	0.00	Pass
24	0.000						
25	0.000	0.004	0.0	0.000	0.006	0.00	Pass
26	0.000						
27	0.001	0.004	0.0	0.001	0.006	0.00	Pass
28	0.000						
29	0.000	0.004	0.0	0.000	0.006	0.00	Pass
30	0.000						
31	0.000	0.004	0.0	0.000	0.006	0.00	Pass
32	0.000						
33	0.000	0.004	0.0	0.000	0.006	0.00	Pass
34	0.000						
35	0.001	0.004	0.0	0.001	0.006	0.00	Pass
36	0.000						
37	0.001	0.004	0.0	0.001	0.006	0.00	Pass
38	0.000						
39	0.001	0.004	0.0	0.001	0.006	0.00	Pass
40	0.000						

**Model: ELP042C0700LSD1**  
**Harmonics – Class-C per Ed. 3.2 (incl. inter-harmonics)**

Current & voltage waveforms

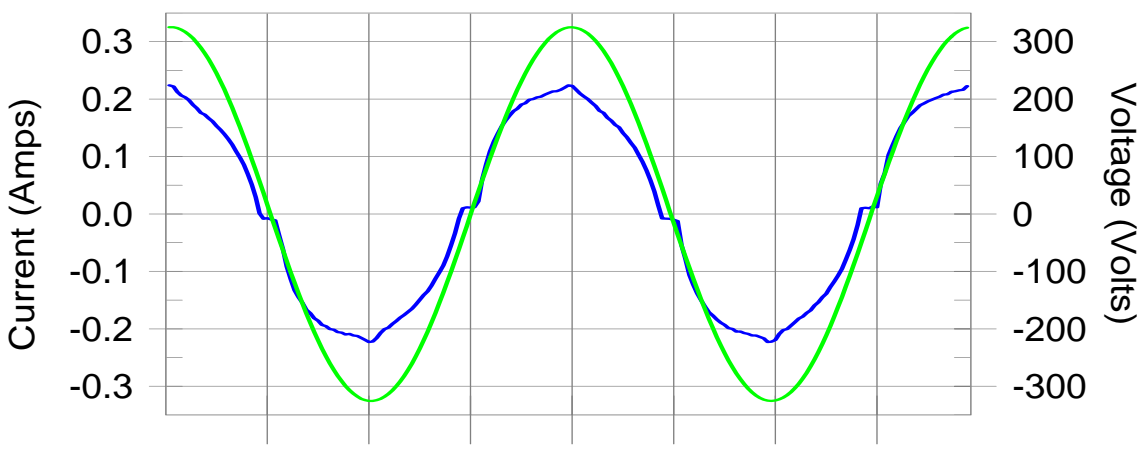

Harmonics and Class C limit line

European Limits

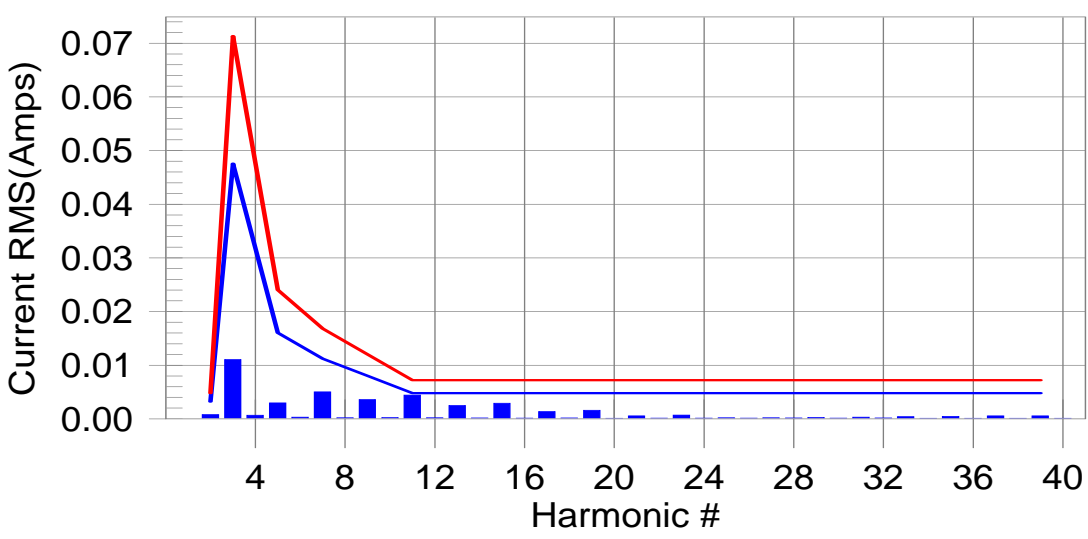

**Test result: Pass Worst harmonics H7-44.95% of 100% limit, H7-33.43% of 150% limit.**



**Current Test Result Summary (Run time)**

Test Result: Pass

Source qualification: Normal

Highest parameter values during test:

V_RMS (Volts):	230.03	Frequency(Hz):	50.00
I_Peak (Amps):	0.227	I_RMS (Amps):	0.161
I_Fund (Amps):	0.160	Crest Factor:	1.426
Power (Watts):	36.6	Power Factor:	0.991

Harm#	Harms(avg)	100%Limit	%of Limit	Harms(max)	150%Limit	%of Limit	Status
2	0.001	0.003	0.0	0.001	0.005	0.00	Pass
3	0.011	0.048	23.3	0.012	0.071	16.83	Pass
4	0.001						
5	0.003	0.016	0.0	0.004	0.024	0.00	Pass
6	0.000						
7	0.005	0.011	44.9	0.006	0.017	33.43	Pass
8	0.000						
9	0.004	0.008	0.0	0.004	0.012	0.00	Pass
10	0.000						
11	0.004	0.005	0.0	0.005	0.007	0.00	Pass
12	0.000						
13	0.003	0.005	0.0	0.003	0.007	0.00	Pass
14	0.000						
15	0.003	0.005	0.0	0.003	0.007	0.00	Pass
16	0.000						
17	0.001	0.005	0.0	0.001	0.007	0.00	Pass
18	0.000						
19	0.002	0.005	0.0	0.002	0.007	0.00	Pass
20	0.000						
21	0.001	0.005	0.0	0.001	0.007	0.00	Pass
22	0.000						
23	0.001	0.005	0.0	0.001	0.007	0.00	Pass
24	0.000						
25	0.000	0.005	0.0	0.000	0.007	0.00	Pass
26	0.000						
27	0.000	0.005	0.0	0.000	0.007	0.00	Pass
28	0.000						
29	0.000	0.005	0.0	0.000	0.007	0.00	Pass
30	0.000						
31	0.000	0.005	0.0	0.000	0.007	0.00	Pass
32	0.000						
33	0.000	0.005	0.0	0.000	0.007	0.00	Pass
34	0.000						
35	0.000	0.005	0.0	0.001	0.007	0.00	Pass
36	0.000						
37	0.001	0.005	0.0	0.001	0.007	0.00	Pass
38	0.000						
39	0.001	0.005	0.0	0.001	0.007	0.00	Pass
40	0.000						

**5.5 Measurement Uncertainty**

The measurement uncertainty for harmonic test is under consideration according to CISPR 16-4-2:2003.

## 6 Flicker

### Test Result: Pass

#### 6.1 Used Test Equipment

Equipment No.	Equipment	Model	Manufacturer
EM001-02	Harmonic & Flicker Test System	5001IX-CTS-400-413	California Instrument

#### 6.2 Block Diagram of Test Setup

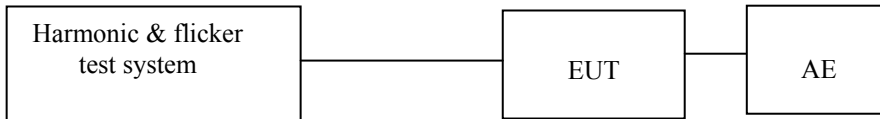

#### 6.3 Test Setup and Procedure

##### 6.3.1 Definition

- Flicker: impression of unsteadiness of visual sensation induced by a lighting stimulus whose luminance or spectral distribution fluctuates with time.
- Pst: Short-term flicker indicator The flicker severity evaluated over a short period (in minutes); Pst=1 is the conventional threshold of irritability
- Plt: long-term flicker indicator; the flicker severity evaluated over a long period (a few hours). Using successive Pst value.
- dc: the relative steady-state voltage change
- dmax: the maximum relative voltage change
- d(t): the value during a voltage change

##### 6.3.2 Test condition

The EUT was set to produce the most unfavourable sequence of voltage changes.

**6.4 Test Data**

**Model: ELP036C0700LSD1**

**Flicker Test Summary (Run time)**

**Test Result: Pass**

**Status: Test Completed**

**Pst, and limit line**

**European Limits**

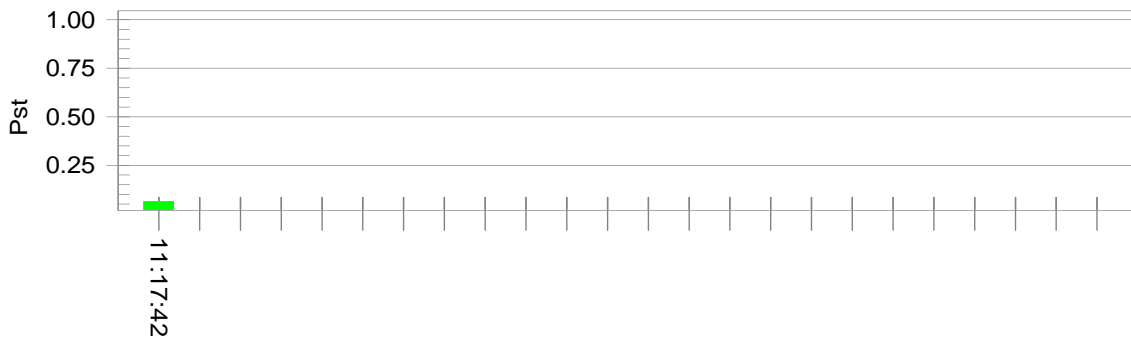

**Time is too short for Plt plot**

**Parameter values recorded during the test:**

<b>Vrms at the end of test (Volt):</b>	<b>229.90</b>		
<b>Highest dt (%):</b>	<b>0.00</b>	<b>Test limit (%):</b>	<b>3.30 Pass</b>
<b>Time(mS) &gt; dt:</b>	<b>0.0</b>	<b>Test limit (mS):</b>	<b>500.0 Pass</b>
<b>Highest dc (%):</b>	<b>0.00</b>	<b>Test limit (%):</b>	<b>3.30 Pass</b>
<b>Highest dmax (%):</b>	<b>0.00</b>	<b>Test limit (%):</b>	<b>4.00 Pass</b>
<b>Highest Pst (10 min. period):</b>	<b>0.064</b>	<b>Test limit:</b>	<b>1.000 Pass</b>

Model: ELP042C0700LSD1

**Flicker Test Summary (Run time)**

Test Result: Pass

Status: Test Completed

Pst, and limit line

European Limits

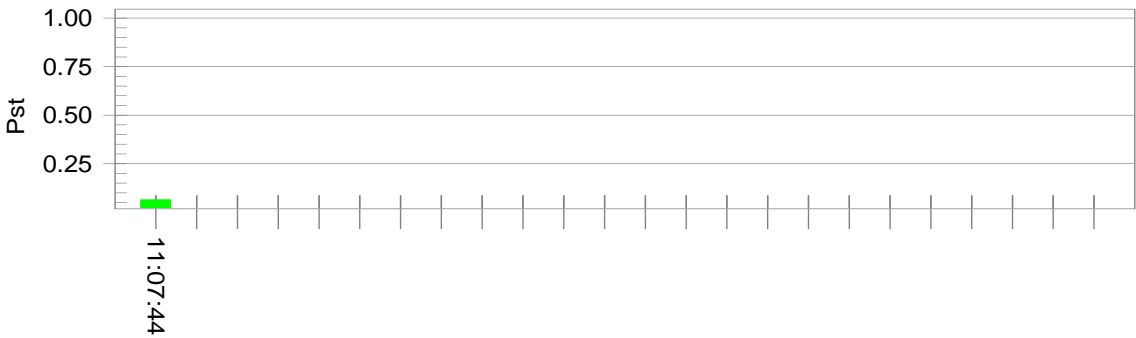

**Time is too short for Plt plot**

Parameter values recorded during the test:

Vrms at the end of test (Volt):	229.82			
Highest dt (%):	0.00	Test limit (%):	3.30	Pass
Time(mS) > dt:	0.0	Test limit (mS):	500.0	Pass
Highest dc (%):	0.00	Test limit (%):	3.30	Pass
Highest dmax (%):	0.00	Test limit (%):	4.00	Pass
Highest Pst (10 min. period):	0.064	Test limit:	1.000	Pass

**6.5 Measurement Uncertainty**

Measurement uncertainty for voltage fluctuation and flicker is under consideration according to CISPR 16-4-2:2003.

## 7 EMS TEST

### Performance Criteria:

- Criterion A: During the test no change of the luminous intensity shall be observed and the regulating control, if any, shall operate during the test as intended.
- Criterion B: During the test the luminous intensity may change to any value. After the test the luminous intensity shall be restored to its initial value within 1 min.  
Regulating controls need not function during the test, but after the test the mode of the control shall be the same as before the test provided that during the test no mode changing commands were given.
- Criterion C: During and after the test any change of the luminous intensity is allowed and the lamp(s) may be extinguished. After the test, within 30 min, all functions shall return to normal if necessary by temporary interruption of the mains supply and /or operating the regulating control.  
Additional requirement for lighting equipment incorporation a starting device:  
After the test the lighting equipment is switched off. After half an hour it is witched on again. The lighting equipment shall start and operate as intended.

### **Measurement Uncertainty**

According to CISPR 16-4-2:2003, measurement uncertainty to immunity test is under consideration.

*Note: "N/A" means Not Applicable in below text.*

### **7.1 EN 61000-4-2(Pursuant to EN 61547) Electrostatic Discharge Immunity**

**Performance criterion: B**

**Test Result: Pass**

#### **7.1.1 Used Test Equipment**

Equip. No.	Equipment	Model	Manufacturer
EM077-02	ESD Simulator	NSG435	SCHAFFNER



### 7.1.2 Block Diagram of Test Setup

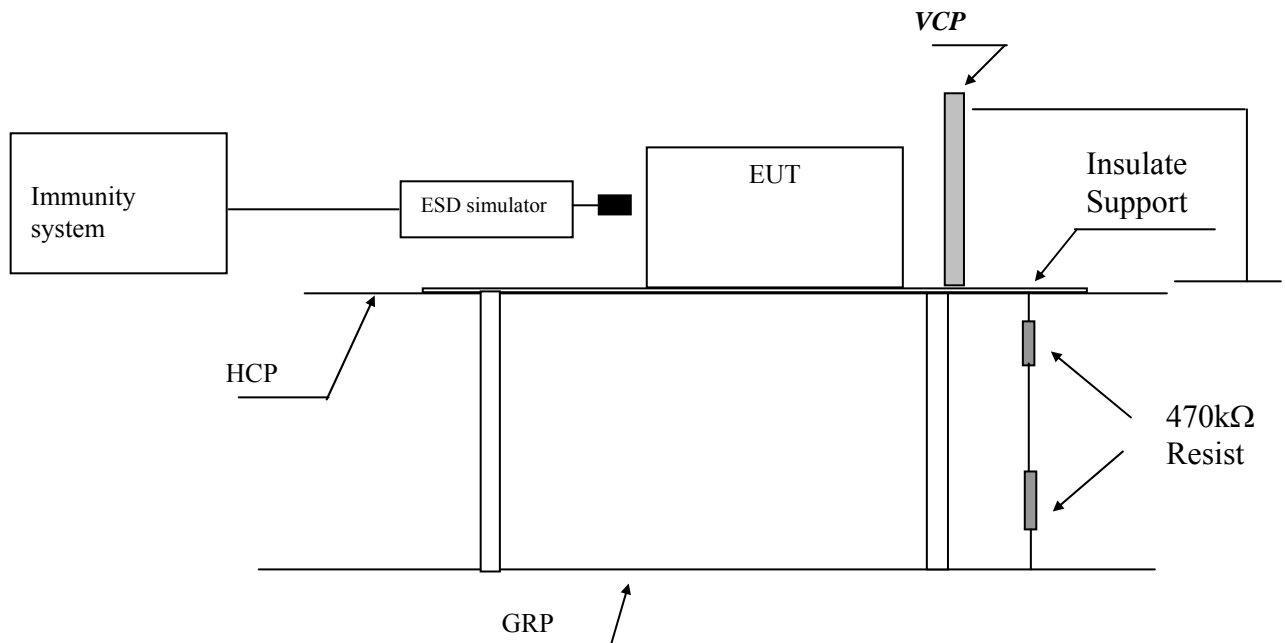

Note: HCP means Horizontal Coupling Plane,  
 VCP means Vertical Coupling Plane  
 GRP means Ground Reference Plane

### 7.1.3 Test Setup and Procedure

The EUT was put on a  $(0,8 \pm 0,08)$  m high wooden table/0.1m high for floor standing equipment standing on the ground reference plane (GRP) 3m by 2m in size, made by iron 1.0 mm thick. A horizontal coupling plane (HCP)  $(1,6 \pm 0,02)$  m by  $(0,8 \pm 0,02)$  m in size was placed on the table, and the EUT with its cables were isolated from the HCP by an insulating support with  $(0,5 \pm 0,05)$  mm thick. The VCP 0.5m by 0.5m in size & HCP were constructed from the same material type & thickness as that of the GRP, and connected to the GRP via a  $470\text{k}\Omega$  resistor at each end.

For floor standing equipment, The EUT shall be isolated from the ground reference plane by an insulating support of 0,05 m to 0,15 m thick. The EUT cables shall be isolated from the ground reference plane by an insulating support of  $(0,5 \pm 0,05)$  mm. This cable isolation shall extend beyond the edge of the EUT isolation.

The distance between EUT and any of the other metallic surface excepted the GRP, HCP & VCP was greater than 0.8m.

The EUT was arranged and connected according to its functional requirements.

Direct static electricity discharges was applied only to those points and surface which are accessible to personnel during normal usage, terminals are excluded.

On each preselected points 10 times of each polarity single discharge were applied .

The ESD generator was held perpendicular to the surface to which the discharge is applied.

The discharge return cable of the generator was kept at a distance of 0.2m whilst the discharge is being applied. During the contact discharges, the tip of the discharge electrode was touch the EUT before the discharge switch is operated. During the air discharges, the round discharge tip of the discharge electrode was approached as fast as possible to touch the EUT.

Indirect discharge was conducted to objects placed near the EUT, simulated by applying the discharges of the ESD generator to a coupling plane, in the contact discharge mode.

After each discharge, the ESD generator was removed from the EUT, the generator is then retriggered for a new single discharge. For ungrounded product, a grounded carbon fibre brush with bleeder resistors ( $2 \times 470 \text{ k}\Omega$ ) in the grounding cable was used after each discharge to remove remnant electrostatic voltage.

10 times of each polarity single discharge were applied to HCP and VCP. The detail selected points are listed in the following table.

### 7.1.4 Test Result

<b>Direct Application of ESD</b>
----------------------------------

#### Direct Contact Discharge

Applied Voltage (kV)	No. of Discharge for each point	Result (Pursuant to EN 61547)	Discharged Points
4	20	N/A	All touchable screws of enclosure, accessible metal parts of the EUT

#### Direct Air Discharge

Applied Voltage (kV)	No. of Discharge for each point	Result (Pursuant to EN 61547)	Discharged Points
8	20	Pass	Air gap of the switch, button, the air in-taking opening, slots around the EUT

<b>Indirect Application of ESD</b>
------------------------------------

#### Horizontal Coupling Plane under the EUT

Applied Voltage (kV)	No. of Discharge for each point	Result (pursuant to EN 61547)	Discharged Point
4	20	Pass	Edge of centre, corner on HCP

#### Vertical Coupling Plane beside the EUT

Applied Voltage (kV)	No. of Discharge for each point	Result (pursuant to EN 61547 criterion B)	Discharged Point
4	20	Pass	Edge of centre, corner on VCP

**7.2 EN 61000-4-6(Pursuant to EN 61547) Injected Current (0.15 MHz to 80 MHz)**

**Performance criterion: A**

**Test Result: Pass**

**7.2.1 Used Test Equipment**

Equip. No.	Equipment	Model	Manufacturer
EM003-01	Conducted Disturbance Generator	CDG_1020	Dr.Hubert GmbH

**7.2.2 Block Diagram of Test Setup**

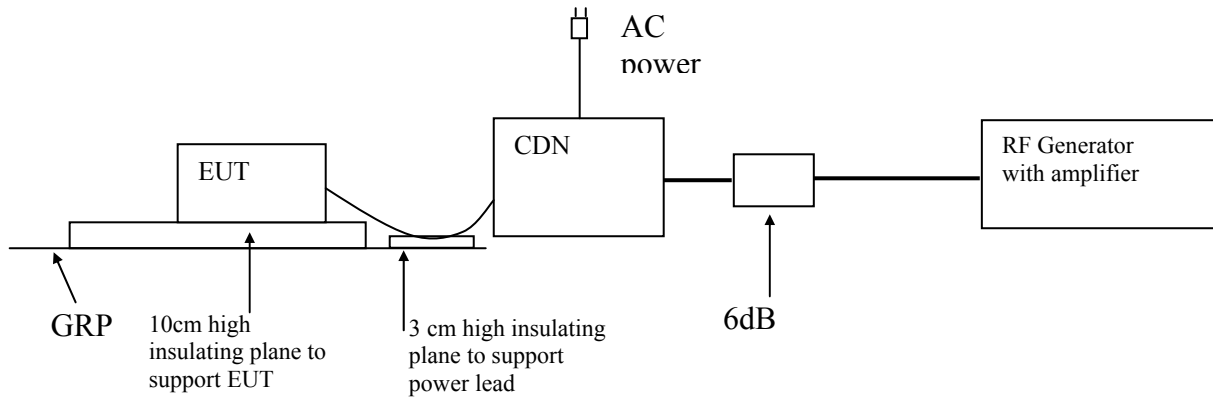

**7.2.3 Test Setup and Procedure**

The EUT was placed on an insulating support of 0.1m height above a ground reference Plane, arranged and connected to satisfy its functional requirement.

All relevant cables were provided with the appropriate coupling and decoupling devices at a distance between 0.1m and 0.3m from the projected geometry of the EUT on an insulating support of 0.03m height above the ground reference plane.

Test voltage was verified before each testing though power meter combined in the RF generator with AMP.

Dwell time was set to 3s and step was set as 1% to keep sufficient response time for EUT.

The frequency from 0.15MHz to 80MHz was checked.

### 7.2.4 Test Result

Port:	Frequency (MHz)	Level (Pursuant to EN 61547)	Result
A.C. Power Lines	0.15 to 80	3V (r.m.s.)	Pass
D.C. Power Lines	0.15 to 80	3V (r.m.s.)	N/A
Signal Lines	0.15 to 80	3V (r.m.s.)	N/A
Control Lines	0.15 to 80	3V (r.m.s.)	N/A

### 7.3 EN 61000-4-4(Pursuant to EN 61547) Electrical Fast Transient/Burst

**Performance criterion: B**

**Test Result: Pass**

#### 7.3.1 Used Test Equipment

Equipment No.	Equipment	Model	Manufacturer
EM005-07	EMS test system	Ecompact 4	HAEFELY

#### 7.3.2 Block Diagram of Test Setup

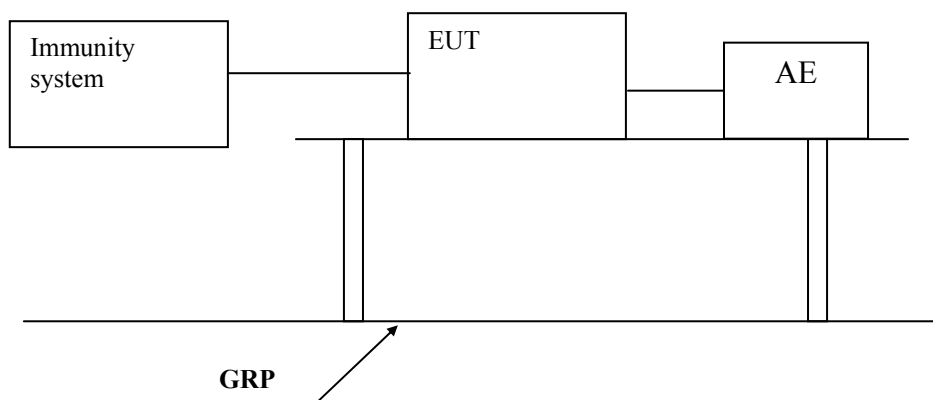

### 7.3.3 Test Setup and Procedure

The EUT was placed on a 0.1m high wooden table, standing on the ground reference plane 3m by 2m in size, made by steel 1mm thick.

The distance between the EUT and any other of the metallic surface except the GRP is greater than 0.5m.

The mains lead excess than 0.5m is folded to avoid a flat coil and situated at a distance of 0.1m above the ground reference plane to insure the distance between the coupling device and the EUT were 0.5m.

The EUT was arranged and connected to satisfy its functional requirement and supplied by the coupling-decoupling network.

### 7.3.4 Test Result

Level (Pursuant to EN 61547)	Polarity	Input and Output A.C. Power Ports	D.C. Power Ports, Signal and Control Lines
0.5kV	+	N/A	N/A
0.5kV	-	N/A	N/A
1kV	+	Pass	N/A
1kV	-	Pass	N/A

**7.4 EN 61000-4-5(Pursuant to EN 61547) Surge Immunity**

**Performance criterion:**  C  
 B (luminaire for emergency lighting)

**Test Result: Pass**

**7.4.1 Used Test Equipment**

Equipment No.	Equipment	Model	Manufacturer
EM005-08	Surge Generator	NSG2050	SCHAFFNER
EM005-08-01	Pulse Network Module	PNW2050	SCHAFFNER

**7.4.2 Block Diagram of Test Setup**

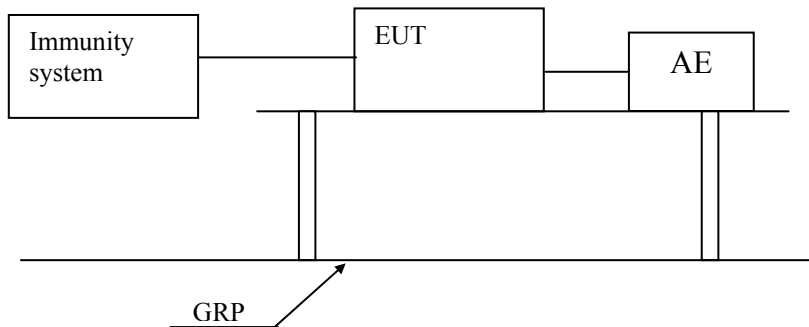

**7.4.3 Test Setup and Procedure**

The surge is to be applied to the EUT power supply terminals via the capacitive coupling network.

Decoupling networks are required in order to avoid possible adverse effects on equipment not under test that may be powered by the same lines and to provide sufficient decoupling impedance to the surge wave so that the specified wave may be developed on the lines under test.

The EUT was arranged and connected according to its functional requirements.

The EUT was placed on a 0.1m high wooden support above the GRP), supplied by the coupling-decoupling network, and arranged and connected to satisfy its functional requirement. The power cord between the EUT and the coupling/decoupling network was less than 2 meters.

Five positive and five negative pulses shall be applied at the peak value and zero crossing points of the a.c. voltage wave.

**7.4.4 Test Result**

- I. For Self-ballasted lamps and semi-luminaires and independent auxiliaries with input power less or equal to 25 W:

Level (Pursuant to EN 61547)	Result
Between Phase And Phase: 0.5kV	N/A
Between Phase And Neutral: 0.5kV	N/A
Between Phase And Earth: 1.0kV	N/A
Between Neutral And Earth: 1.0kV	N/A

- II. For luminaires and independent auxiliaries with input power greater than 25 W:

Level (Pursuant to EN 61547)	Result
Between Phase And Phase: 1.0kV	N/A
Between Phase And Neutral: 1.0kV	Pass
Between Phase And Earth: 2.0kV	N/A
Between Neutral And Earth: 2.0kV	N/A

**7.5 EN 61000-4-11(Pursuant to EN 61547) Voltage Dips and Interruptions**

**Performance criterion:**

for table 11 of EN 61547 ----- C

for table 12 of EN 61547----- B

**Test Result: Pass**

**7.5.1 Used Test Equipment**

Equipment No.	Equipment	Model	Manufacturer
EM005-07	EMS test system	Ecompact 4	HAEFELY

**7.5.2 Block Diagram of Test Setup**

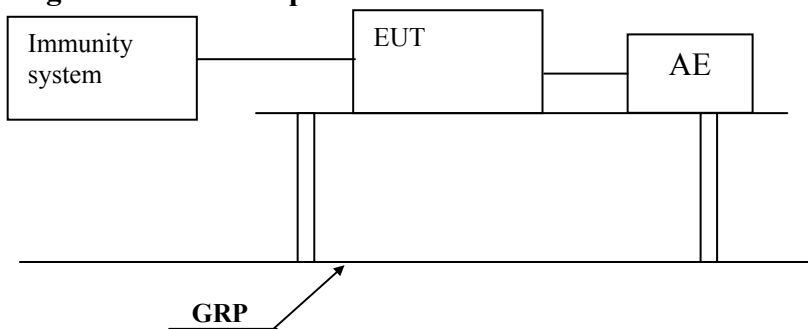



**7.5.3 Test Setup and Procedure**

The EUT was placed on an insulating support of 0.8m height, standing on a ground reference plane, and arranged and connected to satisfy its functional requirement

The test was performed with the EUT connected to the test generator with the shortest power supply cable as specified by the EUT manufacturer.

The EUT was tested for each selected combination of test level and duration with a sequence of three dips/interruptions with intervals of 10 s minimum. Each representative mode of operation was tested.

EUT is tested for voltage reduction of 100%Ut, 0.5 period, 30%Ut, 10 periods, both the positive and negative polarity test was conducted.

Abrupt changes in supply voltage was occur at zero crossings of the voltage and at additional angles considered critical by product committees or individual product specifications preferably selected from 45°, 90°, 135°, 180°, 225°, 270°, 315°.

**7.5.4 Test Result**

I. According to table 11 of EN 61547

Test condition (Pursuant to EN 61547)		Result
Test Level in %U <sub>T</sub>	Duration (in period of the rated frequency)	
70	10	Pass

II. According to table 12 of EN 61547

Test condition (Pursuant to EN 61547)		Result
Test Level in %U <sub>T</sub>	Duration (in period of the rated frequency)	
0	0.5	Pass

Remark: U<sub>T</sub> is the rated voltage for the equipment.

**7.6 EN 61000-4-3(Pursuant to EN 61547) Radiated Electromagnetic Field Immunity**

**Performance criterion: A**

**Test Result: Pass**

**7.6.1 Used Test Equipment**

Equipment No.	Equipment	Model	Manufacturer
SZ061-04	BiConiLog Antenna	3142C	ETS
SZ180-01	Signal Generator	SML03	R&S
SZ181-01	Amplifier	AP32 MT215	PRANA
SZ181-02	Power Amplifier	AS0825-35	MILMEGA
SZ182-01	RF Power Meter	4232A	BOONTON
SZ186-01	Field Probe	HI-6105	ETS
SZ188-02	Anechoic Chamber	RFD-F/A-100	ETS

**7.6.2 Block Diagram of Test Setup**

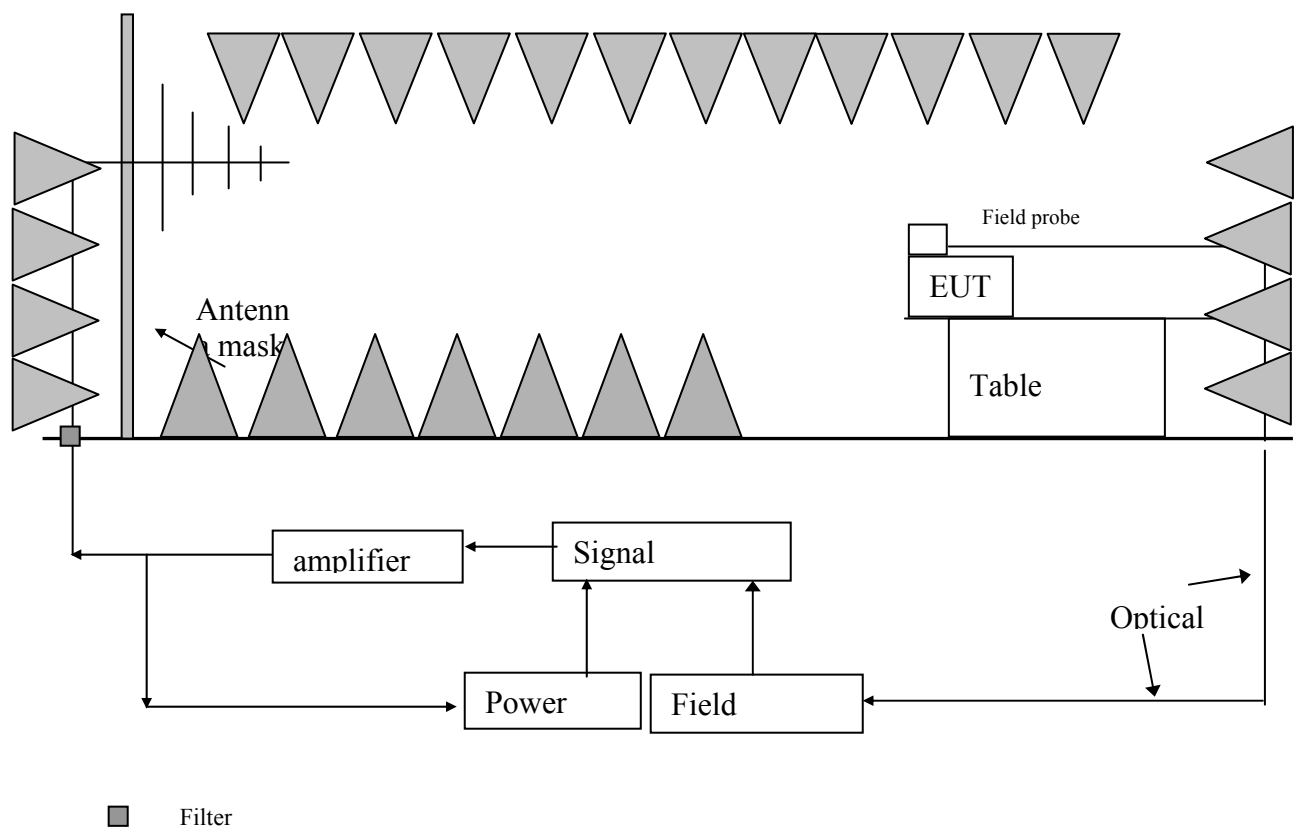

### 7.6.3 Test Setup and Procedure

The test was conducted in an fully anechoic chamber to maintain a uniform field of sufficient dimensions with respect to the EUT, and also in order to comply with various national and international laws prohibiting interference to radio communications.

The equipment is placed in the test facility on a non-conducting table 0.8m high (for floor standing EUT, is placed on a non-conducting support 0.1m height).

The EUT was placed on the uniform calibrated plane which is 3V/m EM field.

For all ports connected to EUT, manufacturer specified cable type and length was used, for those cables no specification, unshielded cable applied.

Wire is left exposed to the electromagnetic field for a distance of 1m from the EUT.

The EUT was arranged and connected according to its functional requirements

Before testing, the intensity of the established field strength have been checked by placing the field sensor at a calibration grid point, and with the field generating antenna and cables in the same positions as used for the calibration, the forward power needed to give the calibrated field strength was measured.

Spot checks was made at a number of calibration grid points over the frequency range 80MHz to 1000MHz, both polarizations was checked.

After calibration, the EUT is initially placed with one face coincident with the calibration plane.

The frequency range is swept from 80MHz to 1000MHz, with the signal 80% amplitude modulated with a 1 kHz sinewave, pausing to adjust the r.f. signal level.

The dwell time at each frequency was 3s so as that the EUT to be exercised and be able to respond.

The step size was 1% of the fundamental with linear interpolation between calibrated points. Test was performed with the generating antenna facing each of the four sides of the EUT.

### 7.6.4 Test Result

Frequency (MHz)	Exposed Side	Field Strength (V/m)	Result
80 to 1000	Front	3V/m (r.m.s.)	Pass
80 to 1000	Left	3V/m (r.m.s.)	Pass
80 to 1000	Rear	3V/m (r.m.s.)	Pass
80 to 1000	Right	3V/m (r.m.s.)	Pass

**7.7 EN 61000-4-8(Pursuant to EN 61547) Power Frequency Magnetic Field Immunity**

**Performance criterion: A**

**Test Result: Not Applicable**

**Remark:**

Equipment containing no Hall elements or magnetic field sensors is not susceptible to magnetic field. Hence, this equipment is deemed to fulfil the magnetic field test.

**8 Appendix I - Photos of test setup (representative)**

Conducted Emission

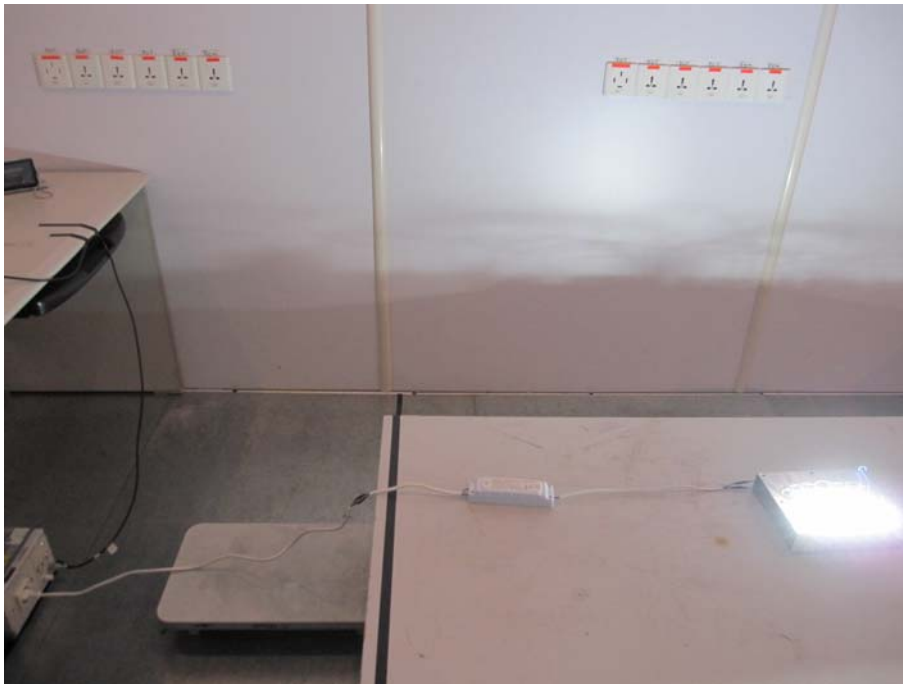

Harmonic & Flicker



ESD Immunity

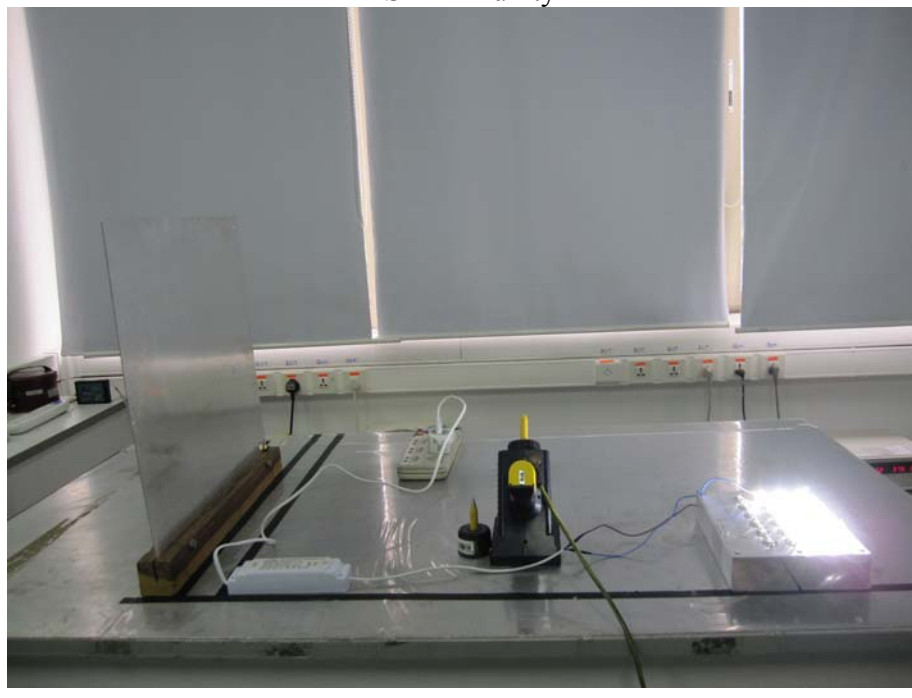

Conducted Immunity



Radiated EM field Immunity

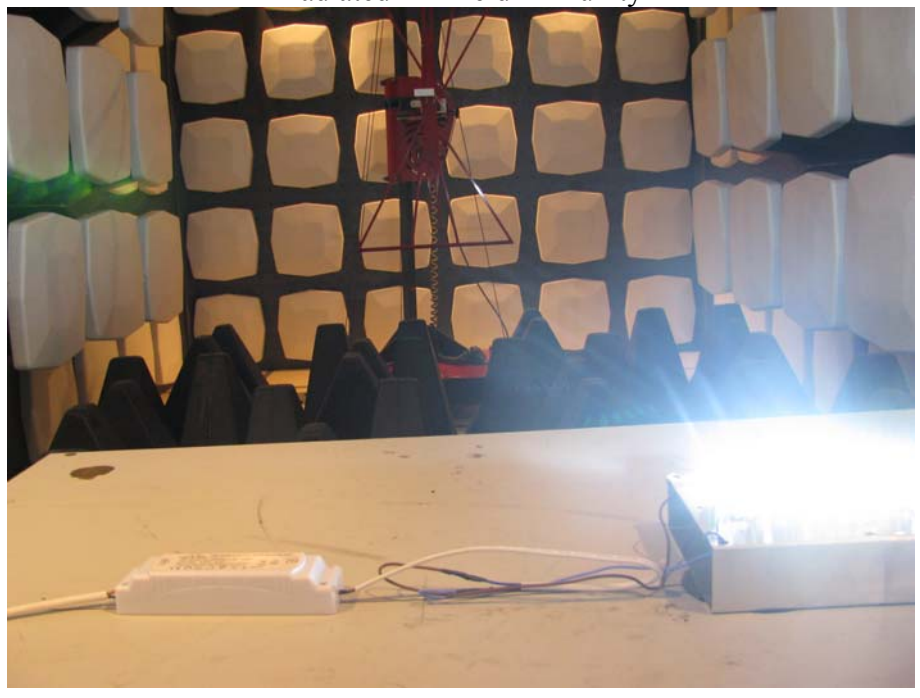

EFT, Dips Immunity

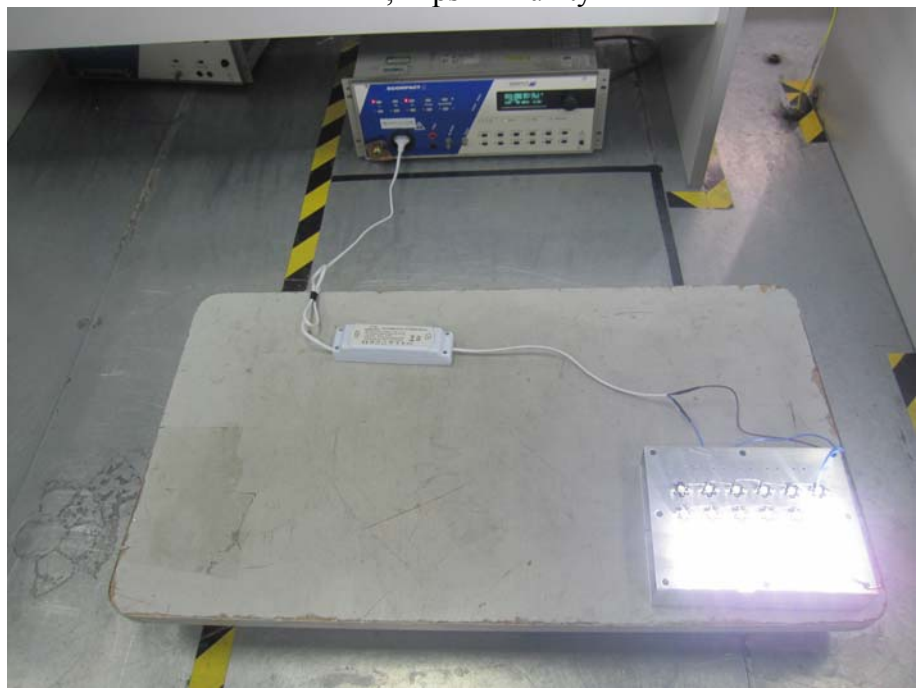

Surge Immunity

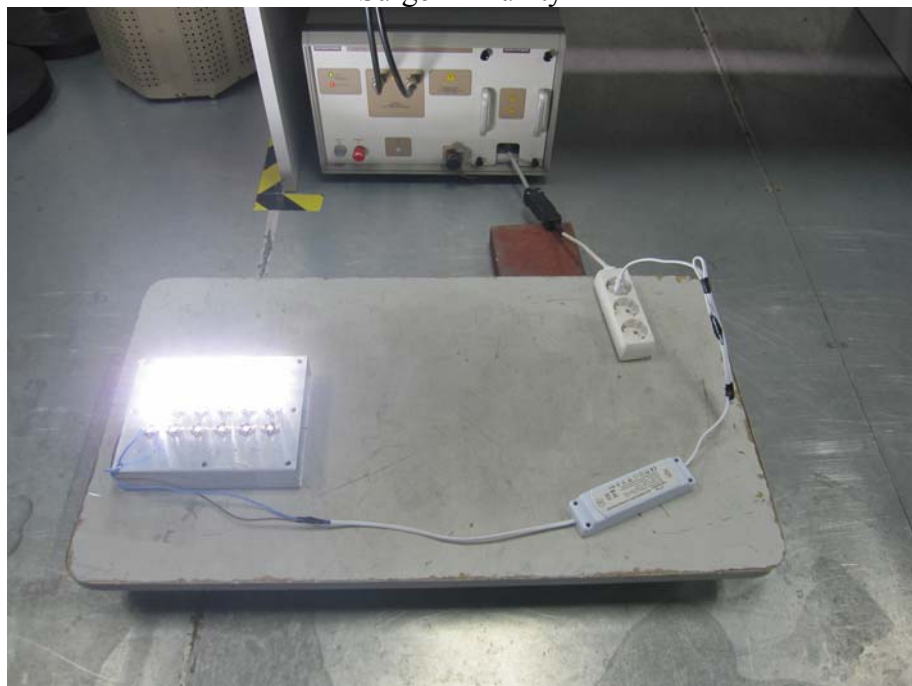

Radiated Electromagnetic Field Disturbance (9kHz-30MHz)





Radiated Electromagnetic Filed Disturbance (30MHz-300MHz)

